

INSTRUCTION MANUAL
MODEL 300
ELECTROMETER
OPERATIONAL AMPLIFIER



KEITHLEY INSTRUMENTS, INC.

TABLE OF CONTENTS

Section	Page	Section	Page
1. GENERAL DESCRIPTION	1	4. MAINTENANCE	23
1-1. General	1	4-1. General	23
1-2. Features	1	4-2. Maintenance Schedule	23
1-3. Specifications	2	4-3. Parts Replacement	23
1-4. Operating Modes	3	4-4. Troubleshooting	24
1-5. Accessories	3	4-5. Troubleshooting Positive and Negative Power Supply Regulators	25
1-6. Equipment Shipped	3	4-6. Troubleshooting the Amplifier	26
2. OPERATION	5	4-7. Calibration	26
2-1. Terminals	5	5. ACCESSORIES	29
2-2. Mounting Instructions	5	5-1. Model 3012 Power Supply	29
2-3. Power Supply	6	5-2. Model 3011 Shielded Switch	31
2-4. Input Connections	7	6. REPLACEABLE PARTS	35
2-5. Output Connections	8	6-1. Replaceable Parts List	35
2-6. Modes of Operation	8	6-2. How to Order Parts	35
2-7. Linear Current Amplifier	10	Model 300 Replaceable Parts List	36
2-8. Logarithmic Current Amplifier	12	Model 3012 Replaceable Parts List	38
2-9. Current Integrator or Charge Amplifier	14	Model 300 Schematic Diagram 19558D	41
2-10. Impedance Matching Amplifier	15	Model 3012 Schematic Diagram 20351B	43
2-11. Voltage Amplifier	17	* Change Notice	Last Page
2-12. Other Modes of Operation	18	* Yellow Change Notice Sheet is included only for instrument modifications affecting the Instruction Manual.	
2-13. Stability, Frequency Response, and Oscillation	18		
2-14. Remote Zero Control	19		
2-15. Connections and Use of Reference Voltages	20		
3. CIRCUIT DESCRIPTION	21		
3-1. General	21		
3-2. Electrometer Input	21		
3-3. Solid State Differential Amplifier	21		
3-4. Positive Power Supply Regulator	22		
3-5. Negative Power Supply Regulator	22		

SECTION 1. GENERAL DESCRIPTION

1-1. GENERAL.

a. The Keithley Model 300 Electrometer Operational Amplifier is a compact, single-ended amplifier. It has greater than 10^{14} ohm input resistance and less than 5×10^{-14} ampere current offset. Its current drift is less than 10^{-15} ampere/24 hours and its current noise is less than 5×10^{-15} ampere peak-to-peak. Primarily a current amplifier, the Model 300 will operate with signals from 10^{-14} to 10^{-2} ampere.

b. Open loop dc voltage gain is 20,000; output is ± 11 volts, 11 milliamperes.

c. The Model 300 is completely solid state except for the input stage. Electrometer input tubes are used because they have less noise, better stability, and are less sensitive to voltage transients than other high impedance devices now available.

1-2. FEATURES.

a. The Model 300 will operate from inexpensive power supplies or batteries. Unregulated supplies with outputs from +16 to +25 volts and -16 to -25 volts will power the Model 300. The Amplifier will also operate from standard 15-volt regulated supplies.

b. An internal zero control is built into the Model 300. In addition, a potentiometer can be connected externally to allow remote zeroing.

c. A regulated reference or polarizing potential of +13.5 volts at 1 milliampere is available.

d. Electrostatic and electromagnetic shields are provided to insure minimum pick-up. Therefore, input and feedback elements can be mounted within the Model 300 case with complete shielding.

e. The Model 300 withstands input overloads up to ± 400 volts and will not be damaged by induced static voltages with the input open.

f. An internal compensation network greatly reduces the possibility of oscillation regardless of external circuitry.

g. The Amplifier is constructed on a 3-1/2 inch by 4 inch printed circuit board that forms a 15-terminal card-edge connector. The input is a Teflon-insulated coaxial connector. Space and mounting terminals are provided for internally mounting input, feedback and output dividing impedances.



FIGURE 1. Keithley Instruments Model 300 Electrometer Operational Amplifier.

1-3. SPECIFICATIONS (Measured at 25°C).

DC VOLTAGE GAIN, OPEN LOOP:

Unloaded: Greater than 20,000.
1000-ohm load: Greater than 12,000.

INPUT CHARACTERISTICS:

Resistance: Greater than 10^{14} ohms.
Capacitance: Less than 10 picofarads.
Current Offset: Less than 5×10^{-14} ampere.
Drift: Less than 10^{-15} ampere/24 hours.
Temperature Coefficient: Less than 10^{-15} ampere/°C.
Voltage Offset: Adjustable to zero.
Drift: Less than 500 microvolts/hour averaged over any 24-hour period after two-hour warm-up.*
Temperature Coefficient: Less than 500 microvolts/°C.*
Input Voltage Noise:
(0.1-10 cps): Less than 5 microvolts rms.
(10 cps-100 kc): Less than 5 millivolts rms.
Current Noise (0.1-10 cps): Less than 5×10^{-15} ampere peak-to-peak.
Overload Limit: ± 400 volts.**

FREQUENCY CHARACTERISTICS:

Closed Loop Unity Gain, Small Signal: dc to 100 kc (-3db).
Slewing Rate: 1 volt/microsecond minimum.
Gain Bandwidth Product: Greater than 150 kc.
Rolloff: Approximately 6 db/octave.

OUTPUT:

Amplifier: ± 11 volts at 11 milliamperes.
Reference Voltage: +13.5 volts at 1 milliampere, regulated to $\pm 0.1\%$ for 10% change in input.

OPERATING TEMPERATURE: 0 to 50°C.

CONNECTORS: Input: push-on coaxial receptacle, Amphenol 2175. All other connections: 15-terminal 1/16 inch card-edge.

POWER REQUIREMENTS:

+16 to +25 volts unregulated, 35 milliamperes plus output current;
-16 to -25 volts unregulated, 8 milliamperes plus output current.
Note: Model 300 will also operate to specifications with standard 15-volt $\pm 0.1\%$ regulated power supplies.

DIMENSIONS, WEIGHT: 3-1/2 inches high x 4 inches wide x 1-1/2 inches deep; net weight, 13 ounces.

ACCESSORIES SUPPLIED: Mating card-edge connector and Teflon-insulated coaxial input connector with shield (chassis mounting).

*With 100% feedback this drift as a percent of full output is less than 0.005%/hour (or/°C.)
**With a 10^5 ohm or greater feedback resistor without a shunting capacitor. May require several hours to recover to specified drift with severe overload.

1-4. OPERATING MODES. The Model 300 is primarily a current amplifier. It can be conveniently used in a number of operating modes: linear current amplifier, logarithmic current amplifier, current integrator and charge amplifier. Section 2 describes these and other operating modes for the Model 300.

1-5. ACCESSORIES (See Section 5.)

a. Model 3011 Shielded Switch can be used with the Model 300 where range switching is required. The Switch is a 3-pole, 8-position, adjustable stop switch. The Model 3011 is constructed for low leakage and to provide shielding for the components. Refer to Section 5 for complete description.

b. Model 3012 Power Supply is designed to power 1, 2 or 3 Model 300s. The Model 3012 delivers positive and negative outputs between 16 and 25 volts, which fill all the power requirements of the Model 300. The Power Supply can be floated up to 500 volts off chassis ground.

c. High megohm resistors are available for using in the Model 300. These resistors may be mounted internally within the Amplifier or in the Model 3011 Shielded Switch. The values available are:

1. Model R20-10⁹ High Megohm Resistor; 10⁹ ohms $\pm 3\%$.
2. Model R20-10¹⁰ High Megohm Resistor; 10¹⁰ ohms $\pm 3\%$.
3. Model R20-10¹¹ High Megohm Resistor; 10¹¹ ohms $\pm 3\%$.
4. Model R20-10¹² High Megohm Resistor; 10¹² ohms $\pm 3\%$.
5. Model R20-10¹³ High Megohm Resistor; 10¹³ ohms $\pm 10\%$.

1-6. EQUIPMENT SHIPPED. The Model 300 is shipped factory calibrated and connected as an open loop operational amplifier. The built-in zero potentiometer (R112) is connected. Feedback and input resistors are not included. Shipped with the Model 300 is a mating 15 terminal card-edge connector, and Teflon insulated input connector with shielding hood.

Pin No.	Designation	Description	Paragraph Reference
INPUT	INPUT	Teflon Insulated Coaxial Input	2-4
1	ALT. INPUT	May be used for large signals	2-4
2	GUARD	Used with ALT. INPUT	2-4
3	B	For remote mounting zero control	2-14
4	A	For remote mounting zero control	2-14
5	-REF	Negative Reference Voltage (-14 volt output)	2-15
6	-16V to -25V	Negative Voltage Supply Input	2-3
7	---	Not used	---
8	OUTPUT	Output	2-5
9	+REF	Positive Reference Voltage (+13.5 volt output)	2-15
10	+16V to +25V	Positive Voltage Supply Input	2-3
11	---	Not used	---
12	---	Not used	---
13	C	For remote mounting zero control	2-14
14	FEEDBACK	For fractional feedback	2-7
15	GROUND	Circuit Ground	2-4

TABLE 1. Model 300 Terminal Explanation.

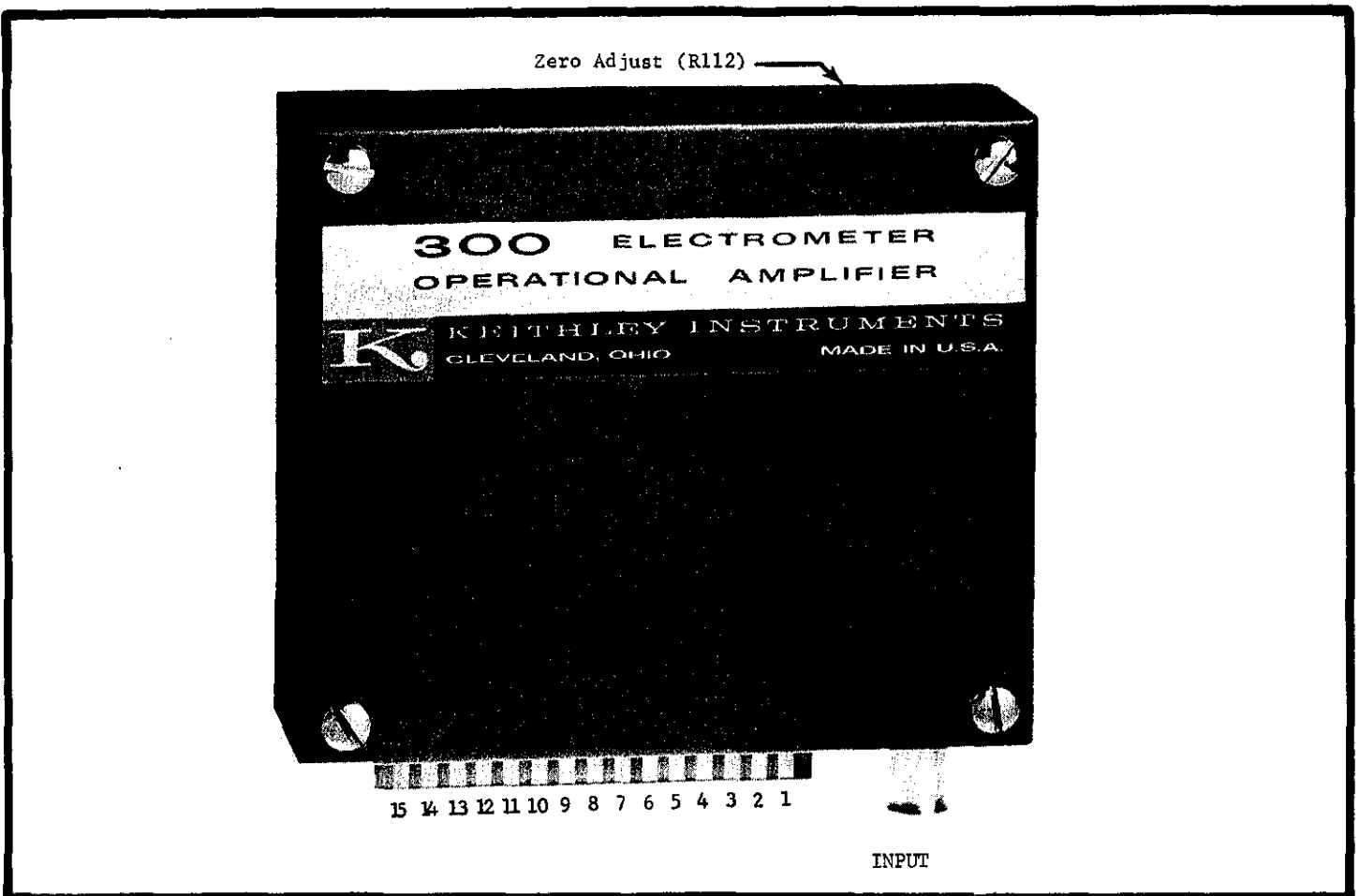

FIGURE 2. Model 300 Terminal Designations. Refer to Table 1 for explanation of the terminals.

SECTION 2. OPERATION

2-1. **TERMINALS.** The Model 300 input connector is a Teflon-insulated coaxial receptacle. The 15-terminal card-edge is used for all other connections. The mating connector for the 15-terminal card-edge is keyed to prevent improper insertion. Refer to Figure 2 and Table 1 for terminal identification and explanation.

2-2. MOUNTING INSTRUCTIONS.

a. The Model 300 is designed for use in various measurement systems. It easily mounts in a convenient location within a system.

b. To mount the Amplifier, attach the furnished card-edge mating connector (Keithley Part No. CS-175-15) and shielded input mating connector (Keithley Part No. CS-179) with the hooded shield (Keithley Part No. CS-180) to a surface. Then plug the Model 300 into the mating connectors. This mounting is acceptable for all positions except when the mating connectors are above the Amplifier. Then, it may be necessary to use a bracket or similar device to hold the Model 300.

c. Mounting the mating connectors CS-179 and CS-175-15. (See Figure 3 for dimensions.)

1. Select the desired surface for mounting.
2. Drill two 1/8-inch diameter holes 2-15/16 inches apart to mount the mating 15-terminal card-edge connector.
3. Drill the 21/64-inch diameter hole for the mating coaxial input connector. (Refer to Figure 3 for exact positions.)
4. Cut out 2-7/16 inch x 3/8-inch plot in chassis.

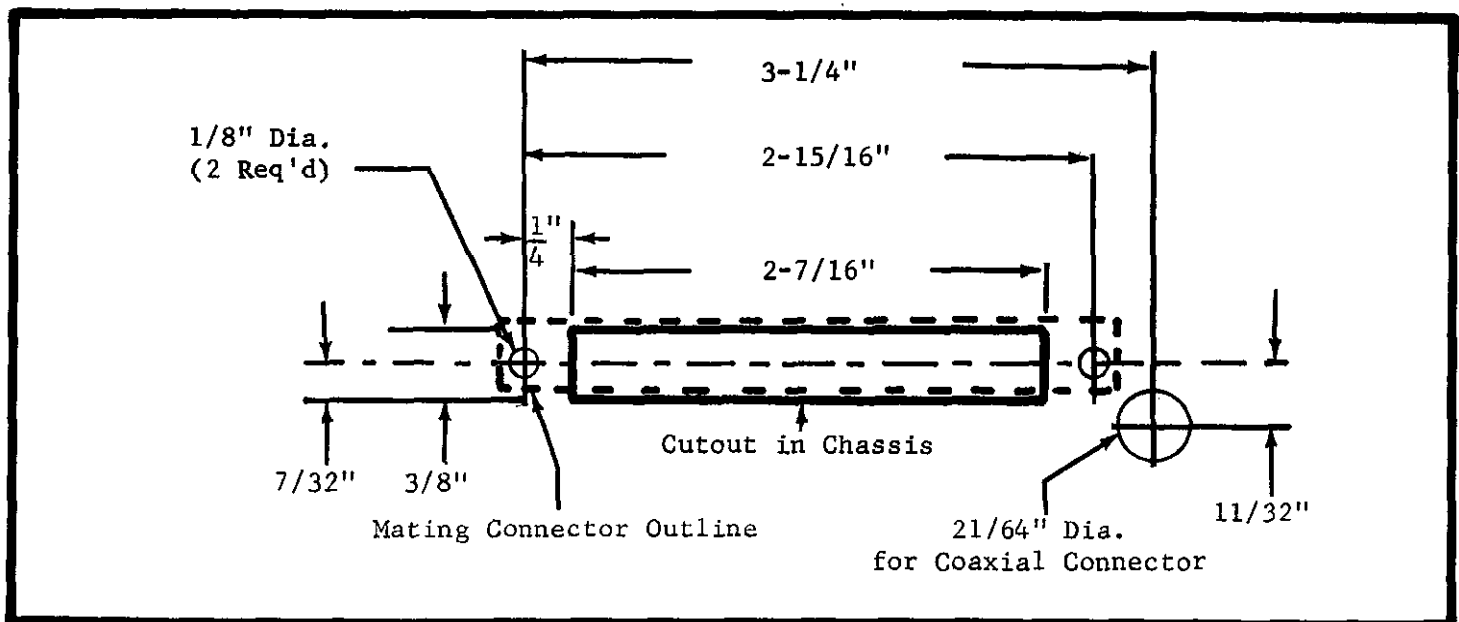

FIGURE 3. Mounting Hole Diagram. This gives dimensions for mounting mating connectors, Keithley Part Nos. CS-175-15 and CS-179.

5. Fasten the connectors in their proper positions.
6. Attach the Model 300 to its mating connectors.

d. The terminals of the mating connectors correspond exactly to the terminals of the Model 300 shown in Figure 2. CS-179 is the mating connector for the INPUT Receptacle, and CS-175-15 is the mating connector for the card-edge connector.

2-3. POWER SUPPLY.

a. The instantaneous value of the supply voltages must be between 16 and 25 volts. For example, even a power supply whose value varies from 16 to 25 volts can be used. The only exception is that a power supply with as low as a 15-volt output regulated to 0.1% can be used. Connect the positive supply to the +16V to +25V Terminal (pin 10, Figure 2). Connect the negative supply to the -16V to -25V Terminal (pin 6, Figure 2).

b. The Model 300 can operate from unregulated power supplies whose minimum instantaneous output falls below 16 volts. However, the positive reference output must be set below the normal 13.5 volts by adjusting the Regulator Adjust Potentiometer, R209, (Figure 22). For example, to use a power supply with a 15-volt minimum output, set the positive reference output to 12.5 volts. Reducing the 13.5 volts of the positive reference output reduces the maximum Amplifier output voltage by a 1:1 ratio; that is, reducing the reference output one volt reduces the maximum output voltage one volt. Adjusting potentiometer R209 is not necessary for 15-volt supplies with 0.1% regulation.

c. The graph in Figure 4 shows where the Model 300 operates satisfactorily. Reliable operation is obtained wherever the slope of the positive reference output voltage versus the supply voltage is approximately 2 millivolts per volt or less. Reliable operation is also obtained wherever the slope of the negative reference voltage output versus the supply voltage is approximately 20 millivolts per volt or less.

d. The Keithley Model 3012 Power Supply provides all the power necessary to drive up to 3 Model 300s (See Section 5). Or, a power supply can be constructed using the circuit shown in Figure 5.

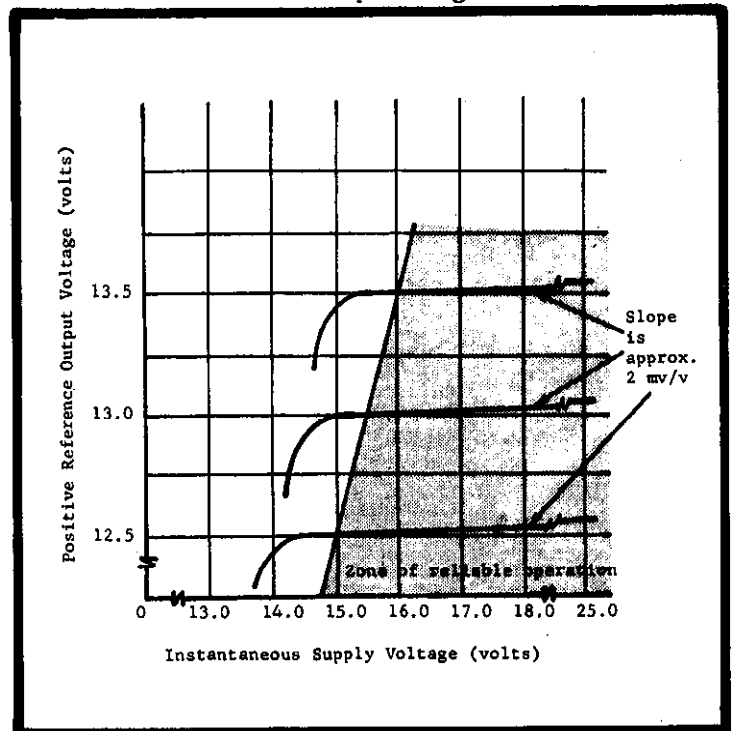

FIGURE 4. Allowable Unregulated Supply Voltages for the Model 300. The Model 300 will operate satisfactorily for a given supply voltage and reference output as long as the slope of the curve is approximately 2 millivolts/volt. As long as the voltage is between 16 and 25 volts, no adjustment is necessary. For instantaneous voltages below 16 volts, reduce the positive reference voltage to remain within the zone of reliable operation. For example, adjust potentiometer R209, the positive reference output, to 12.5 volts when using an unregulated power supply whose instantaneous voltage falls to 15 volts. Similar curves apply for the negative supply voltage. The only variation is that the slope is approximately 20 millivolts/volt.

e. Change the positive reference output by measuring the output at pin 9 with the Keithley Model 153 and adjusting potentiometer R209 (Figure 22).

2-4. INPUT CONNECTIONS.

a. Normally all input signals should be through the INPUT Receptacle. It is specially insulated and shielded to minimize noise which will distort the input signal.

b. For high impedance measurements, carefully shield the input connection and the source being measured, since power line frequencies are well within the pass band of the Amplifier. Unless the shielding is thorough, any alteration in the electrostatic field near the input circuitry will cause extraneous signals to appear at the output.

c. Use high resistance, low-loss materials — such as Teflon (recommended) and polyethylene — for insulation. The insulation leakage resistance of test fixtures and leads should be several orders magnitude higher than the internal resistance of the source. If it is not, leakage losses will cause inaccurate readings. Coaxial cables used should be a low-noise type which employ a graphite or other conductive coating between the dielectric and the surrounding shield braid. Amphenol-Borg Electronics Corporation, Microdot, Inc., and Simplex Wire and Cable Company make satisfactory types.

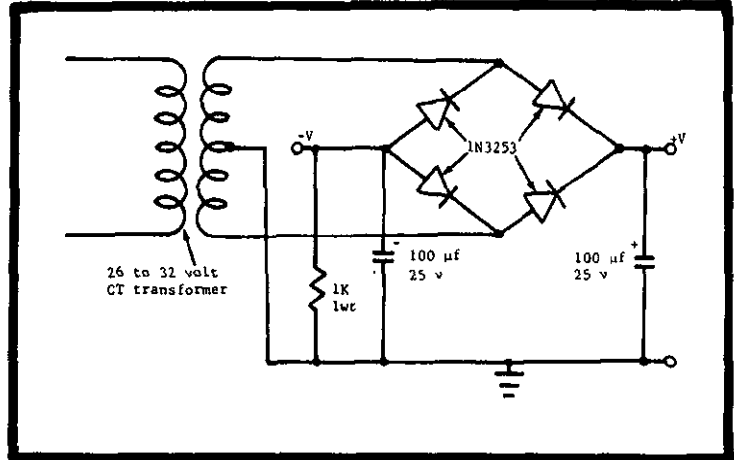

FIGURE 5. Circuit of a Power Supply for the Model 300. Keithley Part No. TR-78 can be used as the transformer in the circuit.

NOTE

Clean and dry connections and cables are very important to maintain the value of all insulation materials. Use pure CH_3OH methyl alcohol to clean Teflon insulation.

d. Any change in the capacitance of the measuring circuit to ground will cause extraneous disturbances. Make the measuring setup as rigid as possible, and tie down connecting cables to prevent their movement. If a continuous vibration is present, it may appear at the output as a signal; other precautions may be necessary to isolate the instrument and the connecting cable from the vibration.

NOTE

Unless otherwise specified all instructions in this manual are for input signals through the INPUT Receptacle.

e. If it is more convenient, the ALT. INPUT Terminal (pin 1, Figure 2) can be used for larger input signals. Note that input leakage current may increase and shielding will become less effective. However, the input tape will still remain guarded. To change from the INPUT Receptacle to the card-edge ALT. INPUT:

1. Remove jumper Q-R (Figure 6).

2. Connect terminal R to hole P (Figure 6) located at the end of the ALT, INPUT tape.

NOTE

Do not use the GUARD Terminal for GROUND, even though GUARD and GROUND are shown connected in the schematic diagram. Severe ground loops may result.

f. The Model 300's input overload limit of ± 400 volts is for 10^5 ohms or greater feedback impedance. This ensures that the output stage will not be damaged by large transient feedback currents. Any combination of resistance and capacitance with 10^5 ohms minimum feedback impedance is acceptable. However, when using a capacitor, the impedance is dependent upon frequency. As frequency increases, impedance is reduced:

$$Z_C = \frac{1}{2\pi f C} \quad \text{equation 1}$$

where Z_C is the impedance in ohms;
 f is the frequency in cps;
 C is the capacitance in farads.

Therefore, if spikes or steps are present in the overload signal, the frequency increases greatly and the impedance decreases. In this situation the feedback impedance is less than 10^5 ohms.

2-5. OUTPUT CONNECTIONS.

a. The output voltage is through the OUTPUT Terminal (pin 8, Figure 2). Almost any means of looking at the output voltage can be employed as long as the load on the output is not less than 1000 ohms.

NOTE

Excessive capacitance loading at the output (usually greater than 1000 picofarads) will cause oscillation. This can usually be stabilized through compensation elsewhere in the circuit (paragraph 2-13).

b. Output overload protection is provided for the Model 300. Thus a temporary direct short to ground at the output is harmless. However, extended periods of shorted output, with the Model 300 in a saturated or near saturated state, may damage the Amplifier.

2-6. MODES OF OPERATION.

a. The Model 300 Operational Amplifier can be used in many different modes of operation through simple adjustment of its circuitry. Paragraphs 2-7 through 2-12 describe the construction and use of several of the modes. Refer to Table 2 for the paragraph describing each operating mode.

b. The Model 300 can be used in these different operating modes through the mounting of various elements in the feedback and input circuits. The components can be mounted within the Model 300 case with complete shielding. To connect multiple feedback or input elements, use the Model 3011 Shielded Switch. The mode of operation is determined by the type of component used and where it is placed in the circuit.

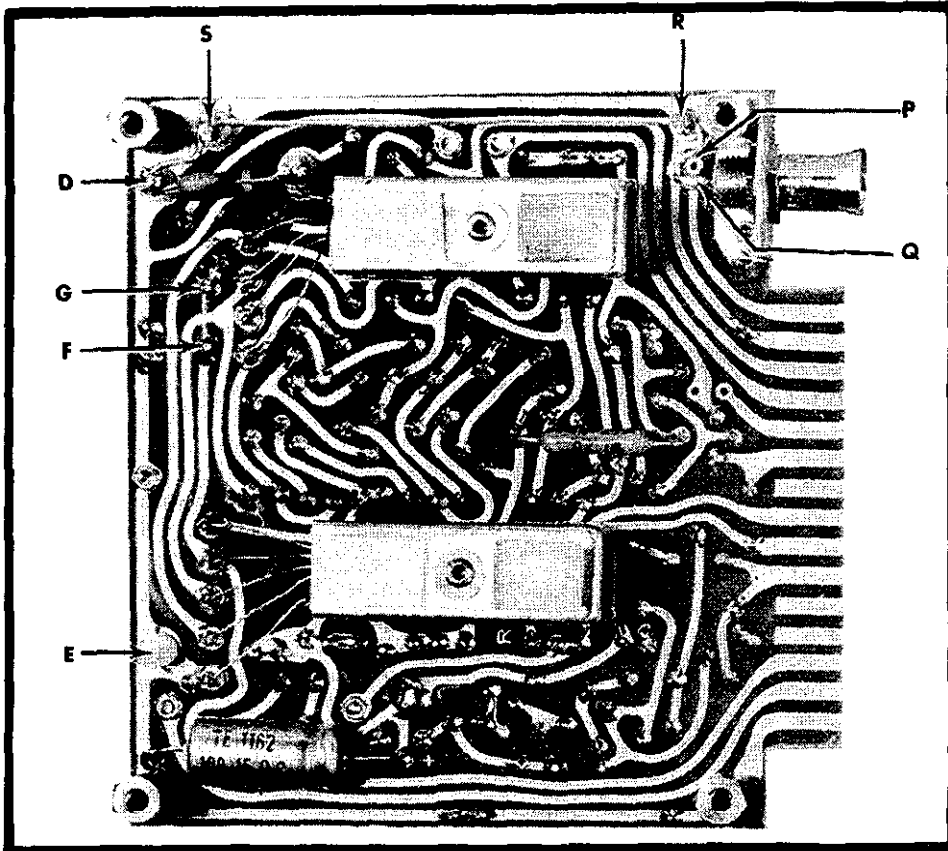
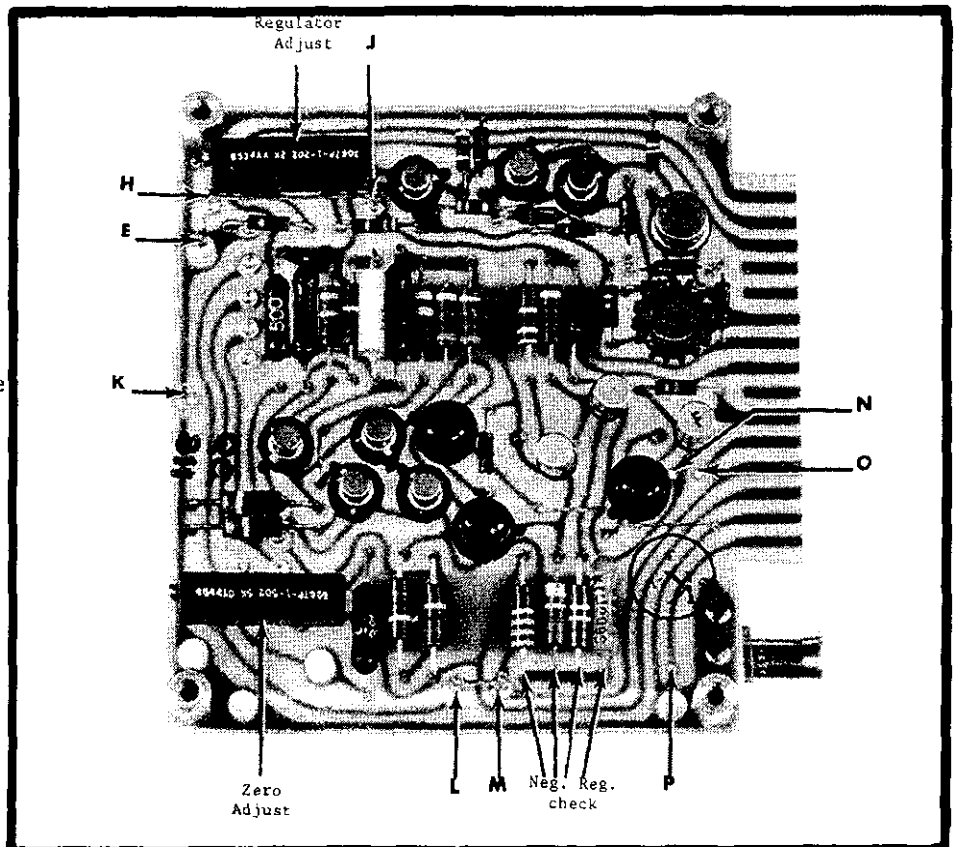

FIGURE 6. Circuit Points Within Model 300. Points are used to construct various circuits referred to in Figures 8 through 15.

FIGURE 7. Circuit Points Within Model 300. Points are used to construct various circuits referred to in Figures 8 through 15.



Operating Mode	Paragraph
Linear Current Amplifier Without Fractional Feedback	2-7
Linear Current Amplifier With Fractional Feedback	2-7
Logarithmic Current Amplifier	2-8
Current Integrator or Charge Amplifier	2-9
Impedance Matching Amplifier	2-10
Voltage Amplifier Without Fractional Feedback	2-11
Voltage Amplifier With Fractional Feedback	2-11
Other Circuits	2-12

TABLE 2. Model 300 Operating Modes and Paragraph Describing the Modes.

c. Figures 8 through 15 illustrate the various modes of operation. The lettered terminals in these figures refer to the lettered points in Figures 6 and 7. Refer to the figures to connect jumpers and to mount elements.

d. Adjusting the Zero Adjust Potentiometer, R112 (Figure 7), sets the output to zero voltage for no input signal. There is a hole in the cover (Figure 2) enabling this adjustment to be made without removing the cover. Refer to paragraph 2-14 for other adjustments.

2-7. LINEAR CURRENT AMPLIFIER (Figures 8 and 9).

a. Placing a resistor in the feedback loop converts the Model 300 to a linear current amplifier. The output voltage depends on the magnitude of the feedback resistor and the input current.

$$V_{out} = -I_{in}R_{fb} \quad \text{equation 2}$$

where V_{out} is the output voltage in volts;
 I_{in} is the input current in amperes;
 R_{fb} is the feedback resistance in ohms.

For a given input current the output voltage can be chosen by selecting the feedback resistor, R_{fb} . By using the largest possible feedback resistor (such as the high megohm resistor accessories), V_{out} can be as much as ± 11 volts. Keeping V_{out} as large as possible results in a better signal-to-noise ratio at the output.

b. Using fractional feedback increases the output voltage gain although drift and noise also increase. Fractional feedback is useful for amplifying different current levels while using only one high megohm resistor in the feedback loop.

NOTE

Be careful when handling the high megohm resistors. Hold these resistors by the ends of the leads; do not touch the glass. Contamination will change the resistor value.

c. Connections for a linear current amplifier without a fractional feedback (Figure 8):

1. Connect jumpers across terminals Q-R, R-S, S-D, E-H, and H-J (Figures 6 and 7).

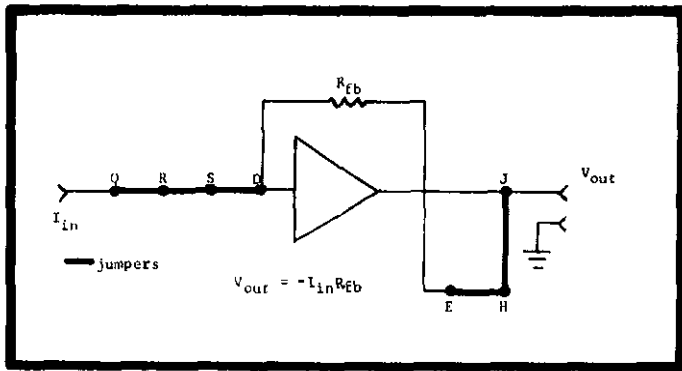

FIGURE 8. Linear Current Amplifier Without Fractional Feedback.

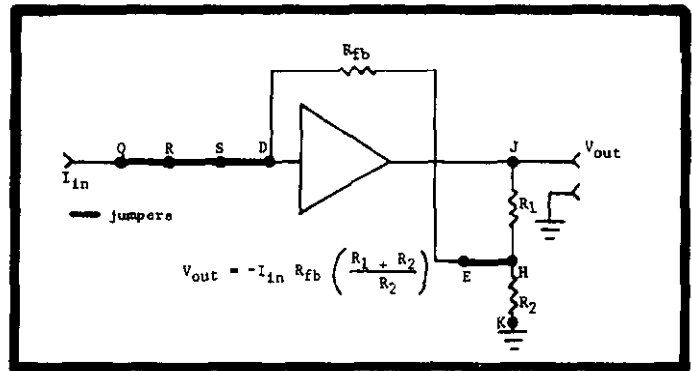

FIGURE 9. Linear Current Amplifier With Fractional Feedback.

NOTE

The Model 300 is shipped from the factory in the linear current amplifier mode minus the element in the feedback loop. Therefore it is shipped with jumpers connected across terminals Q-R, R-S, S-D, E-H and H-J.

2. Remove any element or jumper from across E-K (Figure 7).
 3. Mount the feedback resistor, R_{fb} , in the feedback loop across terminals D and E.
 4. The output voltage for the Model 300 as a linear current amplifier without a fractional feedback is given by equation 2.
- d. Connections for a linear current amplifier with a fractional feedback (Figure 9):
1. Connect jumpers across terminals Q-R, R-S, S-D and E-H (Figures 6 and 7).
 2. Mount the feedback resistor, R_{fb} , in the feedback loop across terminals D and E.
 3. Mount fractional resistors R_1 and R_2 (Figure 9) across terminals J-H and H-K respectively.
 4. The output voltage for the Model 300 as a linear current amplifier with fractional feedback is

$$V_{out} = -I_{in} R_{fb} \left(\frac{R_1 + R_2}{R_2} \right) \quad \text{equation 3}$$

where V_{out} is the output voltage in volts;
 I_{in} is the input current in amperes;
 R_{fb} is the feedback resistance in ohms;
 R_1 and R_2 are the divider resistances in ohms.

NOTE

The current through fractional resistors R_1 and R_2 should be much greater than that through the feedback resistor, R_{fb} , to maintain proper amplification. Also, $R_1 + R_2$ should be greater than 1 kilohm so as not to overload the output.

Feedback Resistor	$10^{10}\Omega$	$10^{10}\Omega$	$10^{12}\Omega$	$10^{12}\Omega$
% Feedback	100%	10%	100%	10%
Output Voltage	10 V	10 V	10 V	10 V
Input Current	10^{-9} amp	10^{-10} amp	10^{-11} amp	10^{-12} amp
Resolution	10^{-11} amp	10^{-12} amp	10^{-13} amp	10^{-14} amp
Current Offset, % of output	0.005%	0.05%	0.5%	5%
Drift/Hour % of output	0.005%	0.05%	0.005%	0.05%
Observed Rise Time	10 msec	20 msec	200 msec	300 msec

TABLE 3. Typical Performance Values for the Model 300 Used as a Linear Current Amplifier. Offset, drift and rise time are affected by the circuit used, but the above table shows some of the Model 300's capabilities. "% Feedback" refers to fractional feedback equation 3; 100% is with no fractional feedback.

e. To mount the divider outside the Model 300, do the following:

1. Connect jumpers across terminals Q-R, R-S, S-D and E-H (Figures 6 and 7).
2. Remove all elements from J-H and H-K.
3. Mount the feedback resistor, R_{fb} , in the feedback loop across terminals D and E.
4. Connect FEEDBACK (pin 14, Figure 2) or terminal H to the center of an external divider. (Terminal H is connected to FEEDBACK).
5. Connect one end of the divider to OUTPUT (pin 8, Figure 2) or terminal J. (Terminal J is connected to OUTPUT). (See NOTE paragraph 2-7d).

2-8. LOGARITHMIC CURRENT AMPLIFIER (Figure 10).

a. Silicon diodes or transistors in the feedback loop make the Model 300 a logarithmic current amplifier. The log characteristic of the element used determines the amplifier performance. 1N459 diodes and silicon transistors usually provide 7 to 9 accurate decades. The leakage current of the element should be at least two magnitudes less than the current being measured.

b. The circuit for the logarithmic current amplifier is shown in Figure 10. This circuit uses a single diode and is for positive currents. The output voltage is:

$$V_{out} = -A \log I_{in} \quad \text{equation 4}$$

where V_{out} is the output voltage in volts;

I_{in} is the input current in amperes;

A is a positive constant, dependent upon the characteristic of the diode.

Amplify negative currents by reversing the diode polarity. Measure both positive and negative polarities by mounting the diodes in parallel and in opposite directions in the feedback circuit. Altering the circuit changes the value of A.

1. Adding diodes in series increases A. Therefore, V_{out} increases for a given input current. This approach reduces the effect of drift, since the drift becomes a smaller percentage of the output voltage.

2. Fractional feedback increases A and thus increases the output voltage, V_{out} . However, this method increases the drift proportionally as the output is increased. The proportionality constant, A, is increased by the amount $(R_1 + R_2)/R_2$. R_1 and R_2 are the fractional feedback resistors as shown in Figure 9. For construction of the fractional feedback, see paragraphs 2-7d and 2-7e.

c. To zero the output, a variable voltage between the log element in the feedback loop and the output is required. This variable voltage can be achieved by use of a biasing network in the feedback loop. The biasing network should consist of a potentiometer in parallel with a battery. Mount this network externally in series between the log element and the output. The log element is available at the FEEDBACK Terminal (pin 14, Figure 2). Connect the Model 300 as in paragraph 2-8e except that any element or jumper should be removed from H-J. Adjusting the potentiometer will select the required voltage drop needed to zero the output. The only requirement of the biasing network is that the current around this network must be much greater than the current through the diode in the feedback loop.

d. Silicon transistors are also useful as log elements and they have better response speed.* Using the basic circuit of Figure 10, positive currents can be amplified by using an NPN transistor in the feedback loop. Negative currents can be amplified by using a PNP transistor in the feedback loop. In both operations the base of the transistor can either be connected to the collector of the transistor or to ground. Connect the collector to the input and the emitter to the output.

NOTE

For further information send for the Keithley Product Note "Using the Model 300 Operational Amplifier as a Logarithmic Current Amplifier."

e. Connections for the Model 300 as a logarithmic current amplifier (Figure 10):

1. Connect jumpers across terminals Q-R, R-S, S-D, E-H and H-J (Figures 6 and 7).
2. Remove any element or jumper from H-K
3. Mount the logarithmic elements in the feedback circuit as needed to amplify positive or negative input currents. Figure 10 shows a diode mounted for positive currents.
4. The output voltage for the Model 300 as a logarithmic current amplifier is given by equation 4.

*For more information on Silicon transistors used as log elements see "A Circuit With Logarithmic Transfer Response Over 9 Decades", by J. F. Gibbons and H. S. Horn, IEEE Transactions on Circuit Theory, September, 1964.

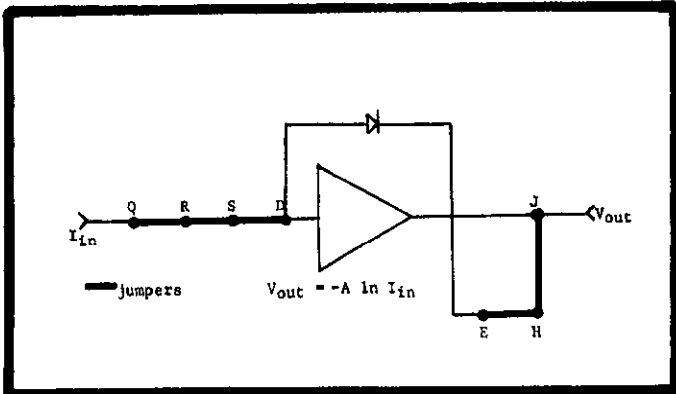

FIGURE 10. Logarithmic Current Amplifier. Diode shown for positive currents.

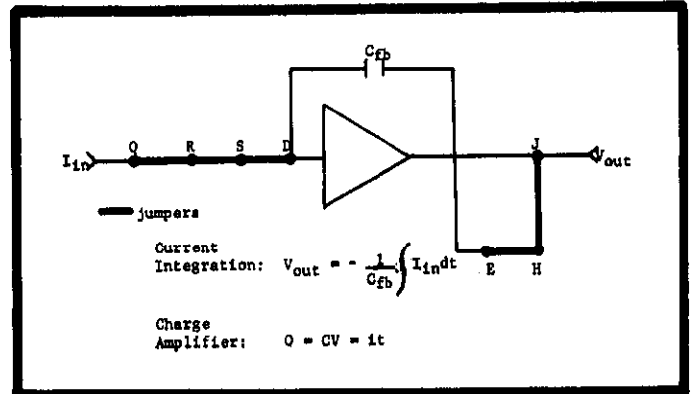

FIGURE 11. Current Integrator or Charge Amplifier.

2-9. CURRENT INTEGRATOR OR CHARGE AMPLIFIER (Figure 11).

a. The current integrator mode and the charge amplifier mode use capacitors in the feedback circuit. These two modes are essentially the same, the only difference being in their purpose.

b. Connections for the Model 300 as a current integrator or charge amplifier (Figure 11):

1. Connect jumpers across terminals Q-R, R-S, S-D, E-H, and H-J (Figures 6 and 7).
2. Mount a capacitor in the feedback circuit between terminals D and E.
3. The output voltage for the Model 300 as a current integrator is

$$V_{out} = \frac{-1}{C_{fb}} \int I_{in} dt \quad \text{equation 5}$$

where V_{out} is the output voltage in volts;
 I_{in} is the input current in amperes;
 C_{fb} is the feedback capacitance in farads.

4. The output voltage for the Model 300 as a charge amplifier is

$$V_{out} = \frac{Q}{C_{fb}} = \frac{I_{in}t}{C_{fb}} \quad \text{equation 6}$$

where V_{out} is the output voltage in volts;
 Q is the applied charge in coulombs;
 C_{fb} is the feedback capacitance in farads;
 I_{in} is the input current in amperes;
 t is the time in seconds.

NOTE

An output divider network can be mounted as described in paragraphs 2-7d and 2-7e.

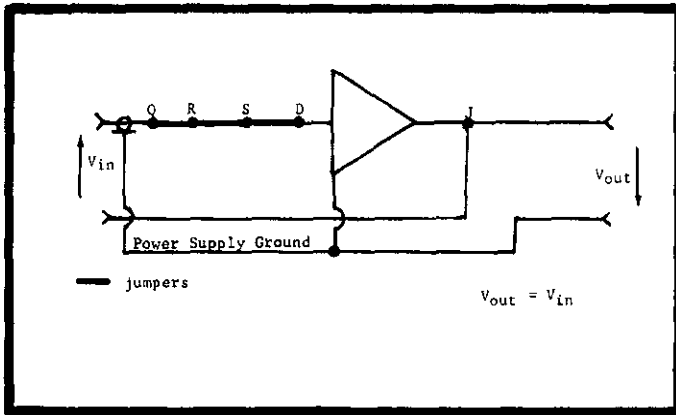

FIGURE 12. Impedance Matching Unity-Gain Amplifier.

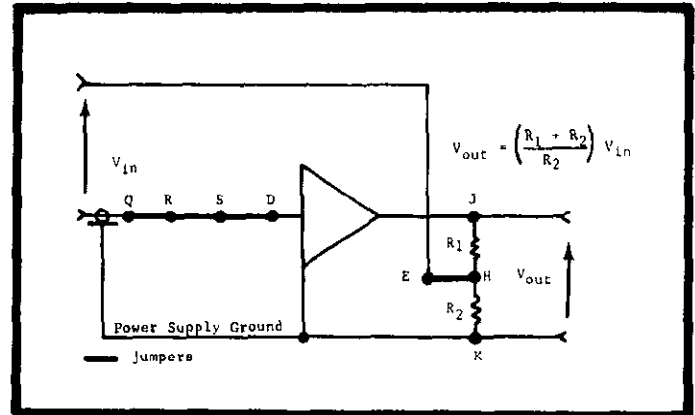

FIGURE 13. Impedance Matching Amplifier with Divided Output.

2-10. IMPEDANCE MATCHING AMPLIFIER (Figures 12 and 13).

a. The Model 300 is an excellent impedance matching amplifier. This mode requires no elements in the feedback circuit. Use the Amplifier in this mode either for unity gain or to obtain voltage gain. Achieve voltage gain using an internal or external dividing network on the output (Figure 13). Use the Model 300 as an impedance matching amplifier only with a floating power supply or a floating signal source from 10 millivolts to 11 volts. Insulate the Model 300 input connector in this mode.

b. Exercise care in grounding when using the Model 300 as an impedance matching amplifier.

1. For the unity-gain amplifier (Figure 12): if the low side of the signal source is grounded, then the high side of the output is grounded. Therefore, the power supply must be floating if the signal source is not.

2. For an amplifier with voltage gain (Figure 13): if the signal source is floating, the power supply need not be floating. If the signal source is grounded, both the power supply and the output monitoring device must float.

3. The Keithley Model 3012 Power Supply meets the floating requirements of the Model 300 (See Section 5). Also available for insulated mechanical support of the Models 300 or 3012 is the Model 3013 Insulated Hold-Down Bracket.

c. Connections for the Model 300 as an impedance matching amplifier (Figure 12):

1. Connect a power supply to the Model 300 (see paragraph 2-3).
2. Connect jumpers across terminals Q-R, R-S and S-D (Figures 6 and 7).
3. Remove all elements from D-E, H-K and H-J.
4. Apply the signal between INPUT and OUTPUT. Monitor the output between OUTPUT and GROUND.

5. The output voltage for the Model 300 as an impedance matching amplifier is

$$V_{out} = V_{in} \quad \text{equation 7}$$

where V_{out} is the output voltage in volts;
 V_{in} is the input voltage in volts.

d. Connections for the Model 300 as an impedance matching amplifier with a divided output (Figure 13):

1. Connect a power supply to the Model 300 (see paragraph 2-3).
2. Connect jumpers across terminals Q-R, R-S, S-D and E-H (Figures 6 and 7).
3. Remove all elements from D-E.
4. Mount divider resistors across J-H and H-K.
5. Apply the signal between INPUT and FEEDBACK. Monitor the output between OUTPUT and GROUND.
6. The output voltage for the Model 300 as an impedance matching amplifier with a divided output is

$$V_{out} = \left(\frac{R_1 + R_2}{R_2} \right) V_{in} \quad \text{equation 8}$$

where V_{out} is the output voltage in volts;
 V_{in} is the input voltage in volts;
 R_1 and R_2 are the divider resistances in ohms.

NOTE

The sum of the resistances of R_1 and R_2 must be at least 1 kilohm. The current through R_1 and R_2 must be much greater than the grid current of the Amplifier.

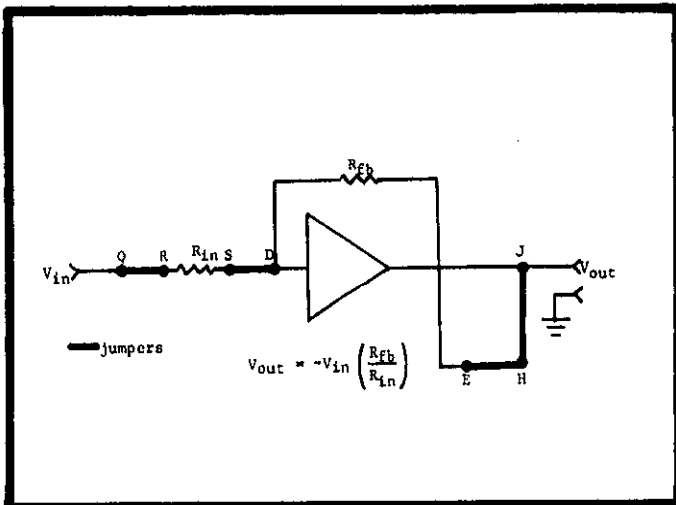

FIGURE 14. Voltage Amplifier Without Fractional Feedback.

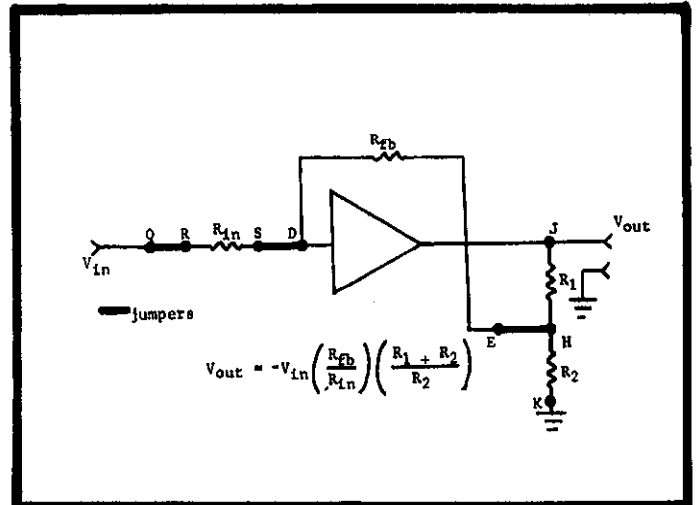

FIGURE 15. Voltage Amplifier With Fractional Feedback.

2-11. VOLTAGE AMPLIFIER (Figures 14 and 15).

a. As a voltage amplifier, the Model 300 uses an input resistor in addition to a feedback resistor. The ratio of the feedback and input resistors determines the voltage gain (equation 9). Use an input resistor whose value is more than 100 times greater than the source resistance to minimize loading the source. The input resistance of the Model 300 in this mode is now the value of the input resistor, R_{in} .

b. Connections for the Model 300 as a voltage amplifier without a divided feedback (Figure 14):

1. Connect jumpers across terminals Q-R, S-D, E-H and H-J (Figures 6 and 7).
2. Mount feedback resistor, R_{fb} , across terminals D-E in the feedback circuit.
3. Mount an input resistor, R_{in} , across terminals R-S.
4. The output voltage for the Model 300 as a voltage amplifier without a divided feedback is

$$V_{out} = -V_{in} \left(\frac{R_{fb}}{R_{in}} \right) \quad \text{equation 9}$$

where V_{out} is the output voltage in volts;
 V_{in} is the input voltage in volts;
 R_{fb} is the feedback resistance in ohms;
 R_{in} is the input resistance in ohms.

c. Connections for the Model 300 as a voltage amplifier with fractional feedback (Figure 15):

1. Connect jumpers across terminals Q-R, S-D and E-H (Figures 6 and 7).
2. Mount feedback resistor, R_{fb} , across terminals D-E in the feedback circuit.
3. Mount input resistor, R_{in} , across terminals R-S.
4. Mount divider resistors, R_1 and R_2 , across terminals J-H and H-K respectively.
5. The output voltage for the Model 300 as a voltage amplifier with fractional feedback is

$$V_{out} = -V_{in} \left(\frac{R_{fb}}{R_{in}} \right) \left(\frac{R_1 + R_2}{R_2} \right) \quad \text{equation 10}$$

where V_{out} is the output voltage in volts;
 V_{in} is the input voltage in volts;
 R_{fb} is the feedback resistance in ohms;
 R_{in} is the input resistance in ohms;
 R_1 and R_2 are the divider resistances in ohms.

NOTE

The current through fractional resistors R_1 and R_2 should be much greater than that through the feedback resistor, R_{fb} , to maintain proper amplification. Also, $R_1 + R_2$ should be greater than 1 kilohm so as to not overload the output.

2-12. OTHER MODES OF OPERATION. The preceding paragraphs describe several modes in which the Model 300 can be used. These modes use basically the same circuit construction. The main difference is the feedback element. Alterations permit many more uses with the Model 300. Some of these possibilities are as voltage integrator, voltage differentiator, current differentiator, adder, open loop voltage comparator, and others.

2-13. STABILITY, FREQUENCY RESPONSE, AND OSCILLATION.

a. A logarithmic plot of an amplifier's dc voltage gain versus the frequency is known as a Bode plot. When the slope of the Bode plot of an amplifier rolls off at 6 db/octave, the amplifier is unconditionally stable. An amplifier is conditionally stable when the roll off is between 6 db/octave and 12 db/octave. An amplifier is unstable and, therefore, will oscillate when its Bode plot rolls off at greater than 12 db/octave.

b. The Keithley Model 300 is a very stable amplifier. The Bode plot of the Model 300 approaches the ideal 6 db/octave through use of an internal roll-off network that stabilizes the amplifier. If the Model 300 did not have a roll-off network, its Bode plot would be similar to the many segmented dotted curve shown in Figure 16. This curve is completely random and uncontrollable. However, the Model 300's internal roll-off network cuts off the high frequency response (moves the slope line to the left). Thus, operation on the natural roll-off curve (dotted line) will never occur. However, due to the many variables present, this 6 db/octave may not be present in every application.

c. The frequency bandwidth of the Model 300 is narrowed, thus improving its stability. The gain-bandwidth product for a stabilized amplifier is 150 Kc, while for the unstabilized amplifier it is about 1 Mc. However, a minor adjustment in the roll-off network can increase the frequency response in the Model 300. In general, increasing the resistance and decreasing the capacitance of the roll-off network (resistor R103, Figure 22, and capacitor C102, Figure 23) will increase the frequency response, although it will also decrease the stability of the amplifier.

d. Additional stability results from placing a very small damping capacitor (3 to 10 picofarads) across the feedback element. This can be useful for stopping oscillation, reducing overshoot of square waves and reducing noise. However, this also has the effect of reducing frequency response and increasing rise time.

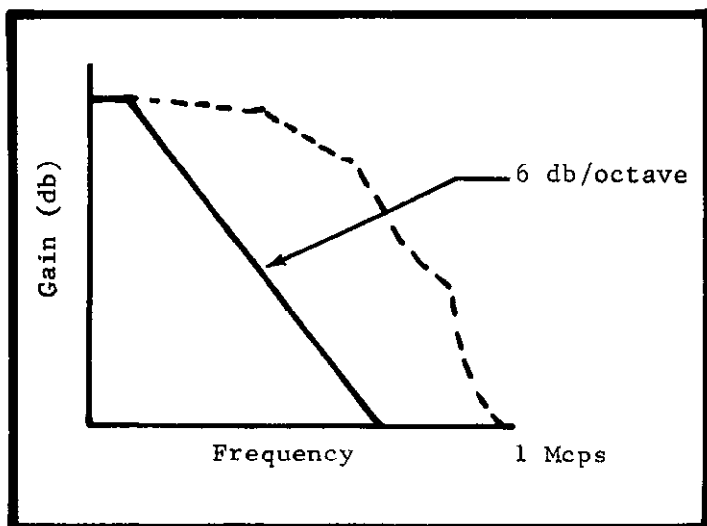

FIGURE 16. Bode Plot for Model 300.

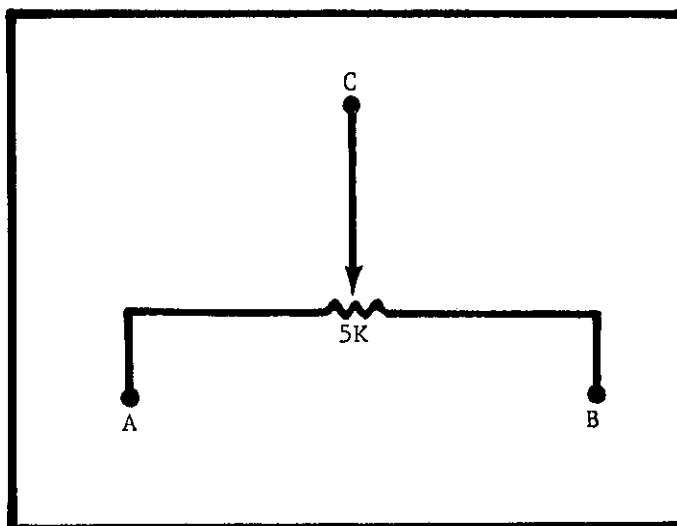

FIGURE 17. Remote Mounted Zero Control. Letters refer to terminals in Figure 2.

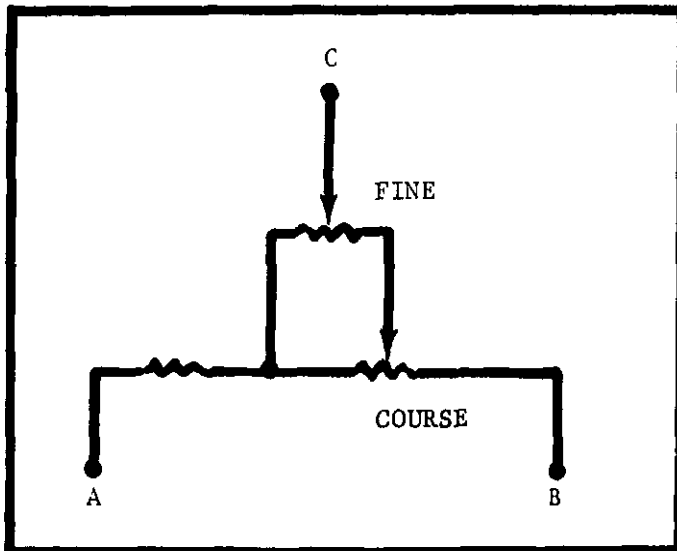

FIGURE 18. Remote Mounted Coarse and Fine Zero Control. Letters refer to terminals in Figure 2.

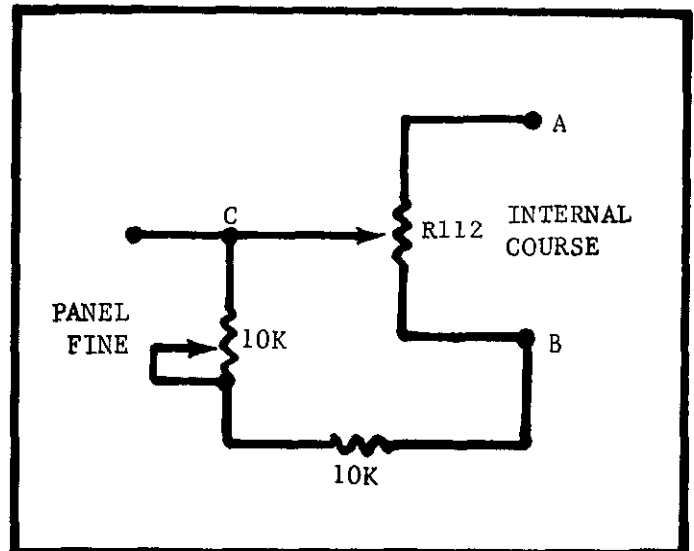

FIGURE 19. Internal Coarse Zero and Remote Mounted Fine Zero. Letters refer to terminals in Figure 2. R112 is already connected within the Model 300.

2-14. REMOTE ZERO CONTROL.

a. The Zero Adjust Potentiometer, R112, is accessible without removing the cover. A simple modification permits finer zero control or external zeroing. This allows remotely locating a zero control in a more convenient place or improving zeroing resolution. External zeroing is possible with several circuits: substituting an external control for the internal control; using the external control for fine zeroing and the internal control for coarse zeroing; using external fine and coarse controls and disconnecting the internal control; or some other arbitrary configuration.

b. The external control can be a 10-turn, 5-kilohm wirewound potentiometer manufactured by several companies. If greater resolution is desired, use a potentiometer with more turns.

c. External zero control connections (Figure 17).

1. Disconnect jumpers F-G and L-M (Figures 6 and 7) to remove potentiometer R112 (Figure 22) from the circuit.

2. Connect the external potentiometer to terminals A, B and C (Figure 2). Refer to Figure 17.

d. External fine and coarse zero control connections (Figure 18).

1. Disconnect jumpers F-G and L-M (Figures 6 and 7) to remove potentiometer R112 (Figure 22) from the circuit.

2. Connect a coarse potentiometer and a resistor in series between pins A and B (Figure 2) of the Model 300 card-edge connector. This potentiometer will become the coarse zero control.

3. Connect a fine zero potentiometer as shown in Figure 18.

4. The total resistance between A and B should be about 5 kilohms.

e. External fine and internal coarse zero control connections (Figure 20).

1. Connect a potentiometer in series with a resistor of at least 10 kilohms between terminals C and A or between terminals C and B, as in Figure 19.

2. Do not disconnect jumpers F-G and L-M.

2-15. CONNECTIONS AND USE OF REFERENCE VOLTAGES.

a. The reference voltages are useful for polarizing voltages for ion chambers, for grid current buckout and for log diode biasing. In normal operation the reference output voltages available are +13.5 volts and approximately -14 volts. The amount of additional current that can be drawn from the + REF Terminal depends on the amplifier output current, the ambient temperature and the supply voltages. Around 8 milliamperes can be drawn from the + REF under the worst conditions; i.e., a full output load, power supply voltage around 25 volts and an operating temperature at 50°C. The negative regulator supplies about 1 milliamperes at these conditions. More current can be supplied under more favorable conditions.

b. Access to Reference Voltages:

1. The +13.5 volt reference is available through the + REF Terminal (pin 9, Figure 2). It is connected at all times and is protected from overloads. A temporary direct short to ground will not cause damage.

2. The negative voltage reference, whose nominal value is approximately -14 volts, is independent of the negative supply voltage and load. The negative regulator output is not connected to the Negative Supply terminal (pin 6, Figure 2). It may be connected by attaching a jumper from O to N, (Figure 6).

NOTE

Overload protection is not provided on the negative reference voltage. Any overload could damage the pass transistor, Q203.

3. Paragraph 2-3 and Figure 4 show the response of reference outputs to changes in power supplies.

SECTION 3. CIRCUIT DESCRIPTION

3-1. GENERAL.

a. The Keithley Model 300 Operational Amplifier uses a pair of high impedance balanced electrometer tubes at its input, followed by solid-state differential amplifier stages. Positive and negative power supply regulators enable the Model 300 to operate from a variety of inexpensive power supplies. Input and feedback elements are easily mounted within the case to provide shielding for the complete circuit, or they may be externally mounted.

b. By using different components — such as resistors, diodes, capacitors — in the feedback circuit, the Model 300 can operate in various modes: linear current amplifier, logarithmic current amplifier, current integrator and so forth.

NOTE

Circuit designations refer to schematic diagram 19558D in Section 6.

3-2. ELECTROMETER INPUT. Two balanced electrometer tubes, V101 and V102, are at the Amplifier input. The input signal is applied to the grid of V101. The tube filaments are operated in parallel from the regulated +13.5 volt supply through dropping resistors R104 and R106. Resistor R101 protects the control grid of the active tube, V101, from excessive grid current due to excessive overload. The input capacitor, C101, is a high-frequency bypass. The control grid of V102 is returned to ground.

3-3. SOLID STATE DIFFERENTIAL AMPLIFIER.

a. An emitter follower stage, transistors Q101 and Q102, matches the relatively high output impedance of the input stage to the low input impedance of the next differential amplifier stage, formed by transistors Q103 and Q104. This latter stage drives a second differential amplifier stage, transistors Q105 and Q106.

b. The final differential stage drives the complimentary pair output stage, transistors Q107 and Q108. Resistors R119 and R120 eliminate any crossover distortion. Resistor R121 and diode D101 are provided as an overload limit when the output voltage is negative. Positive output overload protection is achieved by overload limiting the positive regulator.

c. The zero adjust control, potentiometer R112, adjusts the dc voltage of the screen grid for tube V102. The screen grids of the tubes are returned, in effect, to the emitters of transistors Q103 and Q104. This connection stabilizes the electrometer plate potential and tube operating points.

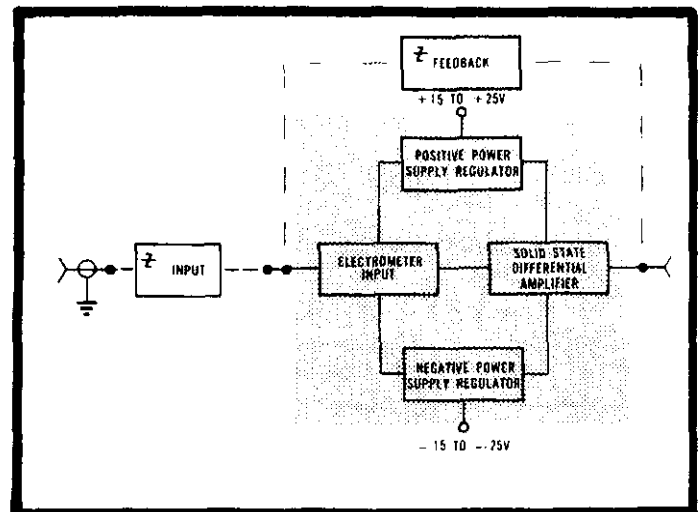

FIGURE 20. Model 300 Block Diagram. The circuit for the Model 300 is within the shaded portion.

3-4. POSITIVE POWER SUPPLY REGULATOR.

a. This circuit regulates the +16 to +25 volt unregulated power supply input to the Model 300. It provides an output adjusted to +13.5 volts for the electrometer tube filaments and for all amplifier stages.

b. To obtain a stable, accurate voltage, the output of the series transistor, Q203, is regulated by comparing a sample voltage from the output dividers, resistors R208 to R210, to the zener reference diode, D205. If a voltage difference exists, it is amplified by a differential amplifier, transistors Q206 and Q207. The signal is further amplified by transistor Q204 and applied to transistor Q201. This transistor is an emitter follower whose function is to increase the current gain of the series transistor, Q203, with which it forms a Darlington pair.

c. Capacitors C201 and C202 prevent high-frequency oscillations. The series resistor, R204, and diodes D201 to D203 provide overload protection. If excessive current is drawn, the voltage drop across resistor R204 increases. This forward biases the diodes which prevent the Darlington pair from supplying additional current.

3-5. NEGATIVE POWER SUPPLY REGULATOR.

a. This circuit regulates the -16 to -25 volt unregulated power supply input to the Model 300. It provides an output of approximately -14 volts to the last three amplifier stages. Since these stages are less critical in the Amplifier operation, the voltage supplied to them is not as well regulated as the positive voltage.

b. The series transistor, Q202, is controlled by sampling the variation of its output and comparing it to the regulated +13.5 volts. The difference is amplified by transistor Q205 and applied to the base of transistor Q202. There is no overload protection.

SECTION 4. MAINTENANCE

4-1. GENERAL. This Section contains the maintenance, troubleshooting and calibrating procedures for the Model 300. Follow these procedures as closely as possible to maintain reliable operation for the Amplifier.

4-2. MAINTENANCE SCHEDULE. The Model 300 requires no periodic maintenance beyond the normal care required of high-quality electronic equipment. The most useful check is to make sure the positive reference output (pin 9, Figure 2) is +13.5 volts $\pm 1\%$.

4-3. PARTS REPLACEMENT.

a. The Replaceable Parts List in Section 6 describes the electrical components of the Model 300. Replace components only as necessary. Use only reliable replacements which meet the specifications.

b. The electrometer tubes, V101 and V102, are specially matched and aged; order these only from Keithley Instruments, Inc., or its representative. In normal use, they should not need replacement before 10,000 hours of operation. They can be checked only by replacement. Standard 5886 tubes could be used in an emergency, but the drift, noise and grid current specifications may not be met.

NOTE

When replacing the electrometer tubes, do not touch the glass base where the leads converge. Increased leakage will result from any contamination.

c. Transistor pairs Q101, Q102 and Q103, Q104 are matched for dc current gain (h_{FE}). Order only from Keithley Instruments, Inc., or its representative. Replace only as pairs.

d. Transistor Q105, Q106 and Q206 are selected for minimum current gain (h_{FE}) of 50. Order only from Keithley Instruments, Inc., or its representative.

Instrument	Use
Keithley Instruments Model 153 Microvolt-Ammeter; 10 μ v to 1000 v, 200 M Ω input resistance, $\pm 1\%$ accuracy, float ± 500 v off ground	Null detector to check amplifier stages
Keithley Instruments Model 610B Electrometer; 10 ⁻¹⁴ to 0.3 ampere, 1 mv to 100 v ranges; $\pm 1\%$ accuracy, 10 ¹⁴ Ω input resistance	Check currents and circuit
Voltage Supply; minimum 10 to 30-volt output, positive and negative; 0.01-volt steps; minimum 35 milliampere output	Source for checking regulators

TABLE 4. Equipment Recommended for Model 300 Troubleshooting. Use these or their equivalent.

NOTE

The accuracy of the Amplifier depends almost exclusively on the accuracy of the associated circuitry. Impedance elements and output monitoring devices determine this. Therefore, use extreme care in selecting and handling these items to minimize leakage and noise.

4-4. TROUBLESHOOTING.

a. The following procedures are for repairing troubles which might occur in the Model 300. Use the procedures outlined and use only specified replacement parts. Table 4 lists equipment recommended for troubleshooting. If the problem cannot be readily located or repaired, Keithley Instruments, Inc., can service the Amplifier at its complete service facilities. Contact your nearest representative.

b. Table 5 contains the more common troubles which might occur. If the repairs indicated do not clear up the trouble, find the difficulty through a circuit-by-circuit check. The schematic diagram contains typical voltages at various points. A properly operating

Difficulty	Probable Cause	Solution
Excessive zero drift	Electrometer tubes defective	Check V101 and V102; replace if faulty
	Regulator(s) defective	Check per paragraph 4-5
Excessive grid current	Excessive humidity or defective electrometer tubes	Check V101 and V102; replace if faulty
Unable to zero output	Amplifier not functioning	Check per paragraph 4-6
	Electrometer tubes have aged and drifted	Check V101 and V102; replace if faulty
	Jumpers F-G and L-M may be disconnected (Figures 6 and 7)	Connect F-G and L-M
Full volt output not obtainable	Faulty regulator operation	Check per paragraph 4-5
	Output overloaded	Remove excessive load
Reference output voltage not correct	Regulator out of adjustment	Adjust potentiometer R209
Regulators do not function	Supply voltages may be dropping below 16-volt minimum	Increase supply voltage (paragraph 2-3)
	Defective regulator circuits	Check per paragraph 4-5
Excessive 60 cps in output	Regulators not functioning	Check per paragraph 4-5

TABLE 5. Model 300 Troubleshooting. See paragraph 4-3 for checking electrometer tubes. Also refer to paragraph 4-4 for step-by-step procedures.

Amplifier will have these values $\pm 10\%$. Voltages were measured with the Model 153. Refer to the Circuit Description in Section 3 to find the more critical components and to determine their function in the circuit.

4-5. TROUBLESHOOTING POSITIVE AND NEGATIVE POWER SUPPLY REGULATORS.

a. Check both the positive and negative power supplies to the Model 300 to make sure they provide between 16 and 25 volts. Check the input power supply currents with the Model 153 or 610B: with no output load, the positive power supply should be approximately +35 milliamperes and the negative power supply approximately -8 milliamperes. Higher input currents indicate one or more transistor has shorted in the regulator or the amplifier.

b. Check the positive regulator output by measuring for +13.5 volts $\pm 1\%$ with the Model 153 at the positive reference output (pin 9, Figure 2). Internally check the negative regulator output by measuring for -14 volts $\pm 5\%$ with the Model 153 at the Negative Regulator Check (Figure 7).

c. Check the regulation of the positive regulator by varying the input voltage. Connect the Voltage Supply to the positive supply (pin 10, Figure 2). Use the Model 153 to monitor the output at pin 9, Figure 2. If the regulator is operating satisfactorily, the positive reference voltage will change no more than 2 millivolts for every 1-volt change to the input between +16 and +25 volts.

d. Check the regulation of the negative regulator similarly. Connect the Voltage Supply to the negative supply (pin 6, Figure 2). Use the Model 153 to monitor the signal at the Negative Regulator Check (Figure 7). If the regulator is operating satisfactorily, the Model 153 will show less than 20 millivolts change for every 1-volt change to the input between -16 and -25 volts.

e. If either regulator is not operating (zero regulation), the series transistor is probably shorted and should be replaced. For the positive regulator, replace Q203 (Figure 23). For the negative regulator, replace Q202 (Figure 23).

f. If the positive regulator has poor regulation, use the following procedure:

1. Remove the positive power supply from the Amplifier.

2. Apply +13.5 volts to the +REF Terminal (pin 9, Figure 2).

3. Measure the voltage at the wiper of potentiometer R209 (Figure 22). The voltage should be about 9 volts. If +13.5 volts is present, then resistor R210 (Figure 22) is either faulty or it is not connected. If 0 volt is present then resistor R208 (Figure 22) is either faulty or it is not connected. If neither +13.5 volts nor 0 volts is present and if the voltage is not about 9 volts, then potentiometer R209 is faulty.

4. If the voltage is about 9 volts, adjust potentiometer R209 a few turns to make sure that this voltage varies. Then check the base voltage of transistor Q206 (Figure 23). This voltage should be between 8.55 volts and 9.45 volts. If it is not, then either resistor R205 (Figure 22) or diode D204 (Figure 23) is faulty. Next, check the collector of transistor Q206 to see if the voltage here varies when potentiometer R209 is adjusted. If it does not vary, then either transistors Q206 or Q207 or both are faulty.

5. Finally, check the voltage at the collector of transistor Q204 (Figure 23) and make sure that there is a response to adjusting R209. If there is no response at the

collector, then transistor Q204 is faulty. If there is a response, then either Q201 or Q203 is faulty.

For the negative regulator, repair is easiest by replacing transistors Q202 and Q205 (Figure 23).

4-6. TROUBLESHOOTING THE AMPLIFIER.

a. Disconnect all feedback elements and short the input to ground. This allows each stage of the amplifier to be individually checked.

b. Connect the Model 153 between the plates (Figure 21) of V101 and V102 (Figure 24). Adjust the zero potentiometer, R112 (Figure 22), for null. If null cannot be reached, check the tubes, the zero control circuit, and transistors Q101 and Q102 (Figure 23). Check the transistors by replacing them and adjusting for null again. If null is now reached, replace the transistor pair with a new pair.

c. Check the next stage by connecting the Model 153 across the emitters of transistors Q101 and Q102 (Figure 23) and adjusting the zero potentiometer, R112 (Figure 22), for null. If null is not reached, check this stage and the base circuit of the next stage. Check the base circuit by removing transistors Q103 and Q104 (Figure 23) and again adjusting for null. If null is now reached, replace Q103 and Q104 with a new pair.

d. Check the next stage by connecting the Model 153 across the collectors of Q103 and Q104 (Figure 23) and adjusting for null. If null is not reached, check this stage and check for shorts in the circuit of Q105 and Q106 (Figure 23).

e. Check transistors Q105 and Q106 by measuring the potential of the collector of Q105 with respect to ground. Note that as adjusting potentiometer R112 (Figure 22) carries the other stages through null, the voltage at the collector should swing from at least -11 volts to at least +11 volts. If this does not occur, disconnect the output stage by removing transistor Q107 and resistor R119. Now repeat adjusting potentiometer R112. If the collector of Q105 still does not swing ± 11 volts, replace transistor Q105 or Q106 or both. If transistors Q105 and Q106 were operating properly, then the defect is in the output stage and replace transistor Q107 or Q108 (Figure 23) or both.

4-7. CALIBRATION. All calibration adjustments are made at the factory and no periodic adjustments are required under normal use. Checking for proper operation as given in paragraphs 4-5 and 4-6 will calibrate the Model 300.

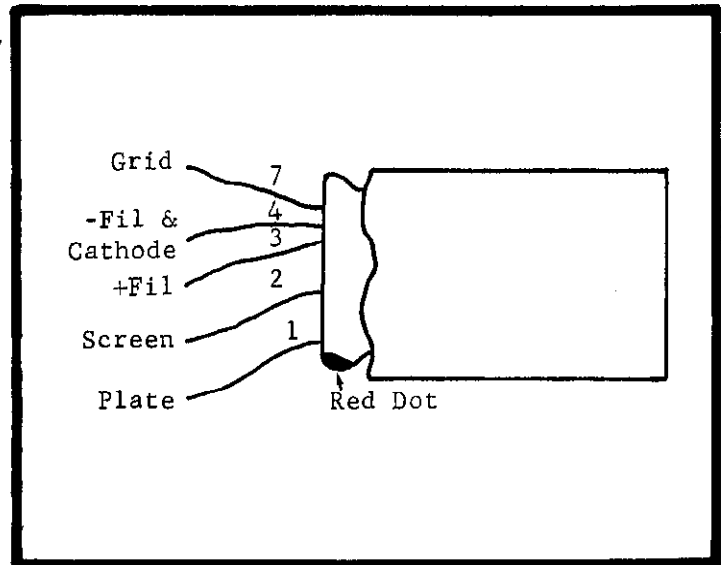

FIGURE 21. Base Connections for Electrometer Tube.

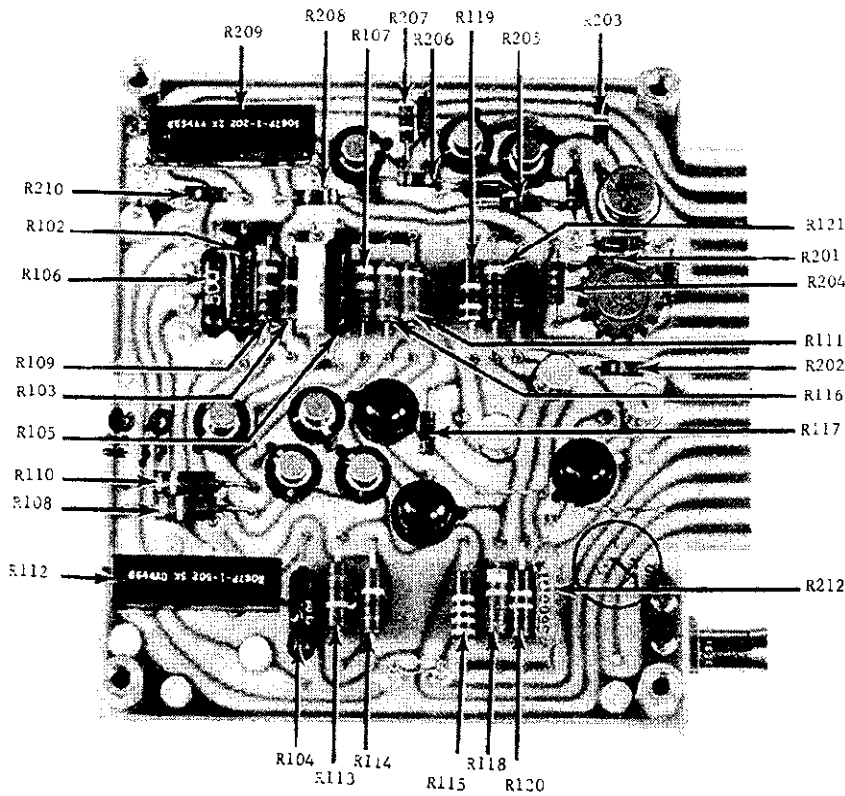

FIGURE 22. Resistor Locations on PC-110, Model 300. For component locations, see Figure 23. For components on other side of PC-110, see Figure 24.

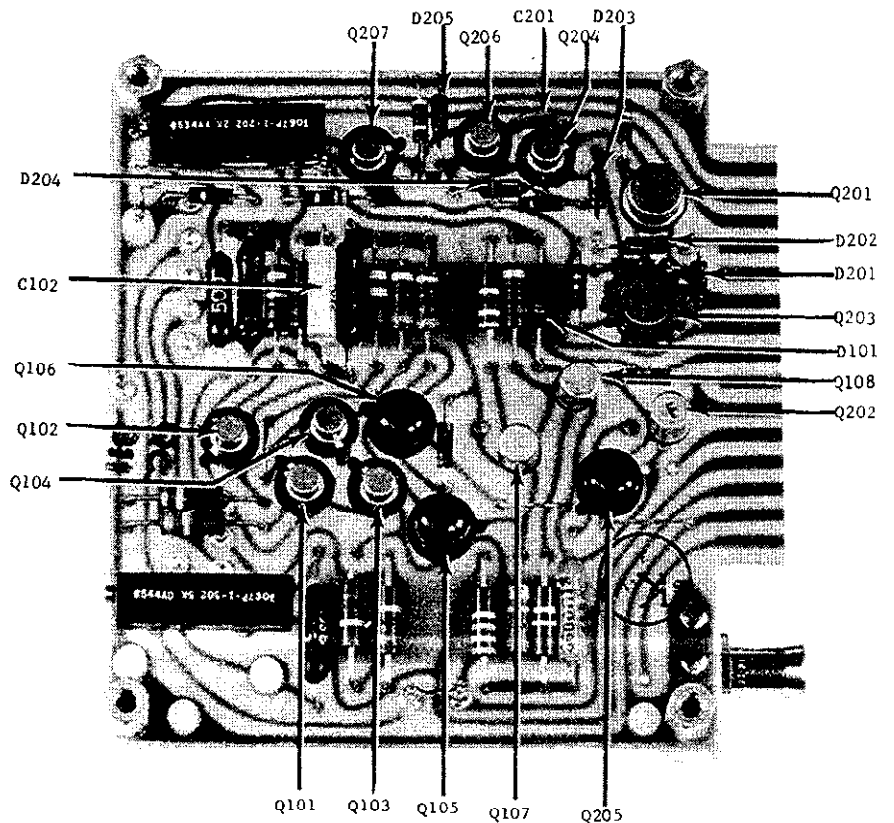

FIGURE 23. Component Locations on PC-110, Model 300. For resistors see Figure 22. For components on other side of PC-110, see Figure 24

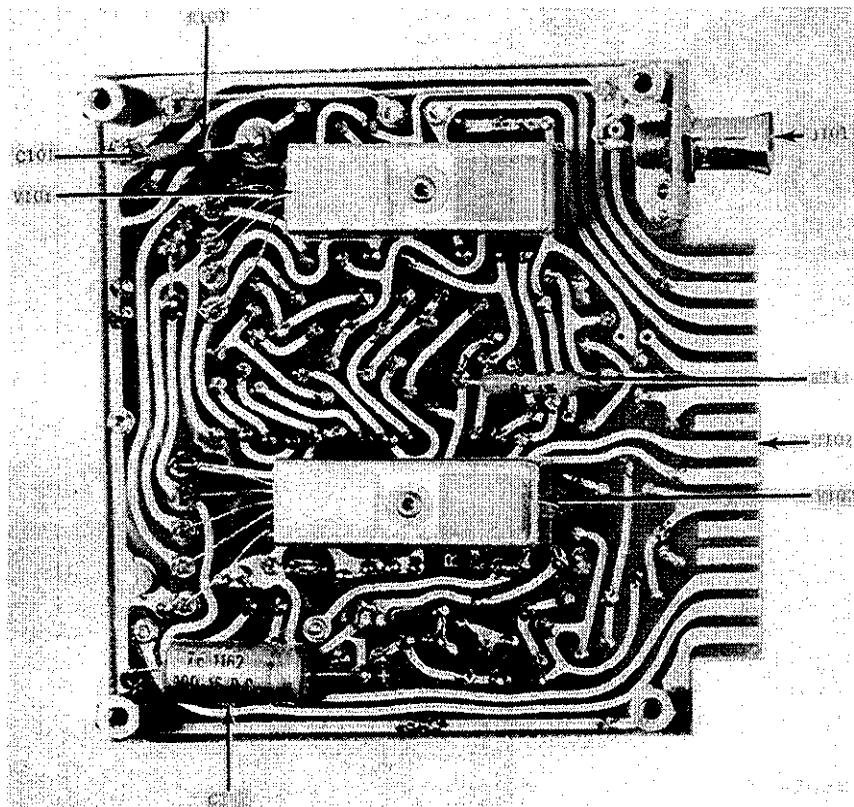

FIGURE 24. Component Locations on PC-110, Model 300. For components on other side of PC-110, see Figures 22 and 23.

SECTION 5. ACCESSORIES

5-1. MODEL 3012 POWER SUPPLY

a. General.

1. The Keithley Model 3012 is a line-operated unregulated power supply. It is a dual supply with positive and negative outputs of 20 volts $\pm 25\%$. The Power Supply can be operated from a line source of 105-125 volts or 210-250 volts.

2. The Model 3012 is for powering the Keithley Model 300 Operational Amplifier. Up to three Model 300s can be driven by the Power Supply without sacrificing performance. It can be floated at up to 500 volts off chassis ground. The Power Supply is a completely self-contained unit and has nearly the same exterior appearance as the Model 300.

3. The Model 3013 Insulated Hold-Down Bracket provides rigid mechanical support for the Model 3012 or Model 300. The Bracket is insulated for use with the Model 300 during floating operation.

b. Specifications.

OUTPUT: As required for 1, 2 or 3 Keithley Model 300 Electrometer Operational Amplifiers.

ISOLATION: Circuit ground to chassis ground; over 10^8 ohms shunted by less than 50 picofarads. Circuit ground may be floated up to 500 volts off chassis ground.

CONNECTOR: 15 terminal 1/16-inch card-edge.

POWER REQUIRED: 105-125 volts or 210-250 volts, 50-60 cps, 10 watts.

OPERATING TEMPERATURE: With one or two Model 300 Amplifiers; 50°C Maximum ambient.
With three Model 300 Amplifiers; 40°C Maximum ambient.

DIMENSIONS, WEIGHT: 3-1/2 inches high x 4 inches wide x 1-1/2 inches deep; net weight, 17 ounces.

ACCESSORIES SUPPLIED: Mating card-edge connector.

ACCESSORIES AVAILABLE:

Model 3013 Insulated Hold-Down Bracket: Provides rigid support for Models 300 or 3012.



FIGURE 25. Keithley Model 3012 Power Supply.

c. Operation.

1. The Model 3012 has a 15-terminal card-edge connector, which is part of the pc board, that is used for all connections. A mating card-edge connector is supplied with the Model 3012. The mating connector is keyed so that the Model 3012 cannot be reverse connected to its mating connector.

NOTE

The Model 3012 can power up to three Model 300 Amplifiers. If more than three Model 300's are used with one Model 3012, then the Power Supply will provide less than the required voltages to each Model 300.

2. To secure the Model 3012 in operating position, first mount the input mating connector on an appropriate surface. See Figure 3 for mounting hole diagram. The mounting procedure for the Model 3012 is the same as for the Model 300 except that the 3012 does not have a coaxial connector. Check the power line voltage and frequency. Next, wire the power line to the Model 3012 mating connector. The method of wiring the power line to the Model 3012 mating connector terminals is different for the 105-125 volt source than it is for the 210-250 volt source. Refer to Figure 26 for wiring instructions.

a. For a 105-125 volt source, connect one lead from the power cord to terminals 1 and 2, and connect the other lead to terminals 3 and 4. See Figure 26a.

b. For a 210-250 volt source, connect one lead to terminal 1, one lead to terminal 4 and connect terminals 2 and 3 together. See Figure 26b.

3. Connect the +16 to +25V Terminal on the Model 3012 mating connector to the +16 to +25V Terminal on the Model 300 mating connector. Connect the -16 to -25V Terminal on the Model 3012 mating connector to the -16 to -25V Terminal on the Model 300 mating connector. Connect the GROUND Terminal on the Model 3012 to the GROUND Terminal on the Model 300.

4. In floating operation, connect the Model 3012 CASE to the circuit ground of the system. In normal operation, connect the Model 3012 CASE and GROUND Terminals to the Model 300 GROUND.

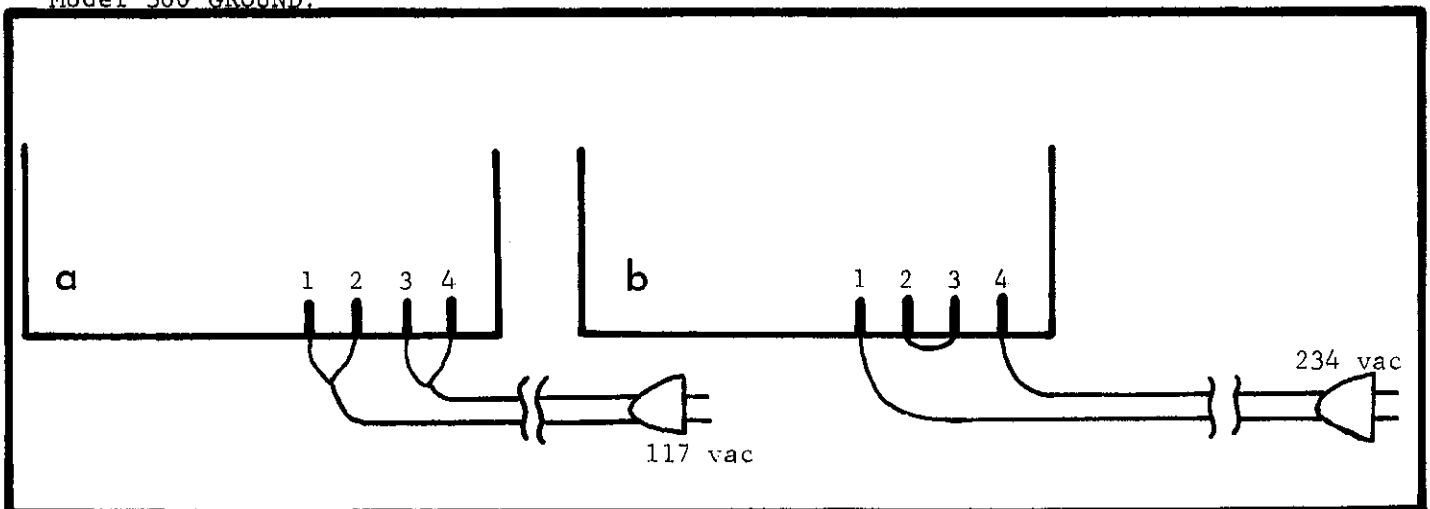

FIGURE 26. Diagrams for Wiring the Power Line to the Model 3012 Connector. Diagram 26a is for a 105-125 volt source and diagram 26b is for a 210-250 volt source.

NOTE

In floating operation one Model 3012 should not be used to power more than one Model 300 unless they have a common ground.

5. Plug the Model 3012 into its mating connector.

d. Circuit Description. The Model 3012 Power Supply has a dual-primary transformer which is connected in parallel from a 105-125 volt ac power source and in series from a 210-250 volt ac power source. This is a result of the wiring from the ac power cord to the primary transformer. The transformer secondary winding is center tapped for dual full-wave rectification by a diode bridge configuration, D101 through D104. The positive output of the diode bridge is filtered by capacitor C101, and the negative supply is filtered by capacitor C102. A bleeder resistor, R101, improves load regulation for the negative output.

e. Maintenance.

1. The Keithley Model 3012 Power Supply has no adjustments or controls. All calibration adjustments are made at the factory and no periodic adjustments are required under normal use.

2. No trouble should occur under normal use. However, if problems arise, then use the following procedures:

a. If there is no output from the Model 3012, check for a blown fuse.

b. If there is a low or high voltage output of the Model 3012, check the line voltage and make sure that the power cord is wired to the mating connector correctly.

5-2. MODEL 3011 SHIELDED SWITCH.

a. General. The Keithley Model 3011 Shielded Switch is a 3-pole, 8-position adjustable stop switch. The Model 3011 is constructed for low leakage and to provide shielding for the components. One deck, which accommodates the feedback or input resistors, is Teflon insulated with greater than 10^{14} ohms insulation resistance between terminals and ground. The switch contains two additional decks for these or other components, such as divider or damping networks. Three Teflon-insulated bnc connectors provide electrical access to the Model 3011.

b. Mounting (Figure 28).

1. For best results mount high megohm resistors in the four clockwise positions. The hole in the Teflon insulated deck (4) has Teflon insulated bushings in these four positions. The extra deck (2) can be

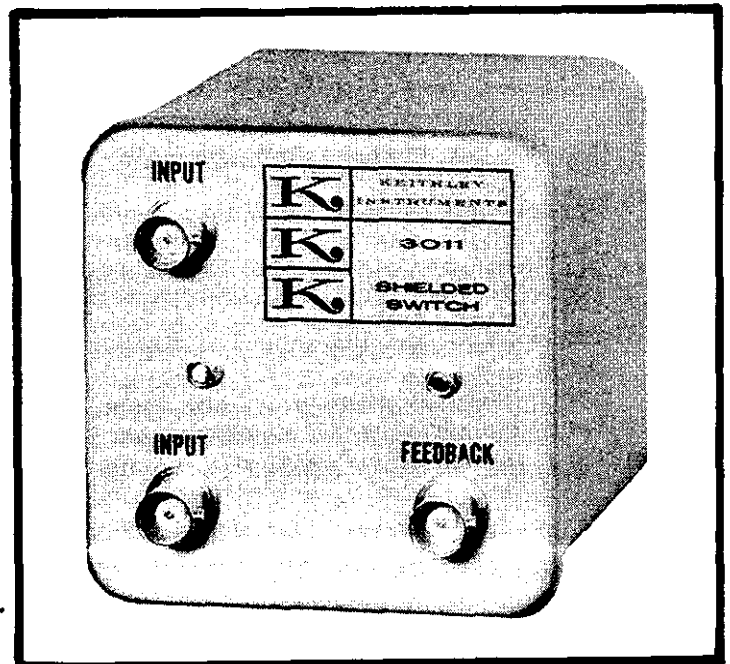

FIGURE 27. Model 3011 Shielded Switch.

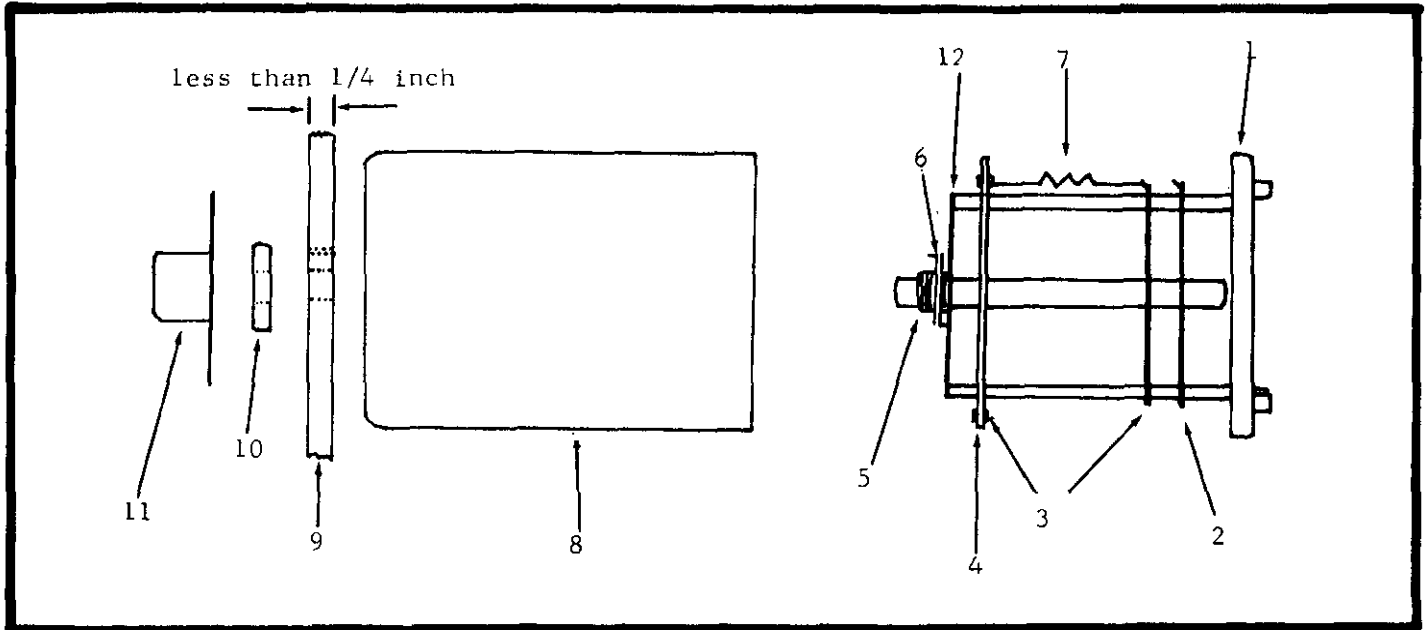

FIGURE 28. Model 3011 Shielded Switch Diagram.

used for mounting divider or damping components.

2. The panel (9) should be less than 1/4 inch thick and should have holes drilled into it for the bushing and lug (Figure 29). The panel, in conjunction with the bushing and lug, physically stabilizes the Model 3011 Switch.

3. Insert the short lug (6) into the desired hole in the front plate (12) of the Switch. This adjusts switch stopping. Insert the larger lug over the bushing against the first lug. This second lug should face opposite the first lug.

4. Insert the Switch into its shield. Make sure the bushing (5) and the larger lug (6) are fitted into the proper holes on the front panel of the shield.

5. Insert the bushing and lug into the panel (9).

6. Secure the Switch and panel with the nut and lockwasher (10).

7. Attach the knob (11) to the Switch.

c. Installation and Hook-up for Switching Feedback (Figure 30).

1. One INPUT Receptacle on the Model 3011 is used as the input to the system. The other INPUT Receptacle is used as the input to the Model 300 INPUT Receptacle. Use bnc connectors and coaxial cables with the Model 3011 INPUT Terminals.

2. Connect the Model 3011 FEEDBACK Terminal to the Model 300 OUTPUT Terminal. Single unshielded cable may be used for the Feedback. Use bnc connectors with the FEEDBACK Terminal.

Item (See Figure 28)	Description
1	Rear Cover (No. 19487B)
2	Extra Deck
3	Component Mounting Decks
4	Teflon Insulated Deck
5	Threaded Bushing
6	Lugs (2 required)
7	Component positions
8	Shield (No. 19402A)
9	Panel (not furnished with Switch)
10	Nut and lockwasher
11	Knob (No. 16338A)
12	Front Plate

TABLE 6. Model 3011 Callout and Description

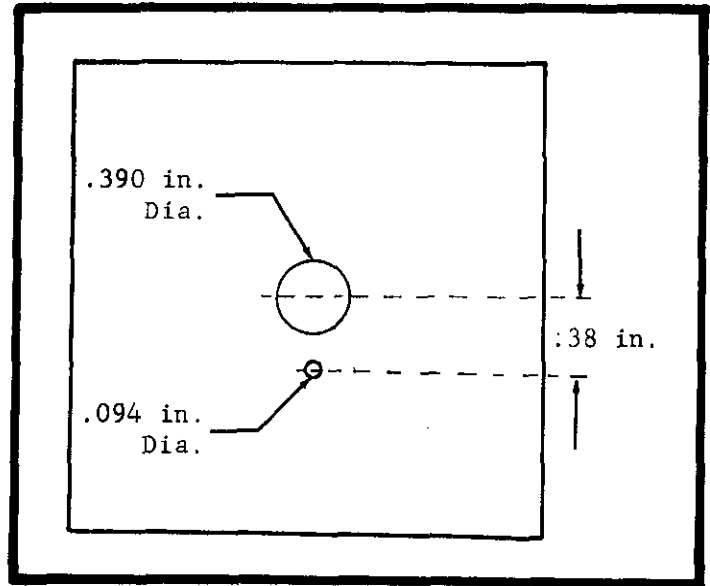

FIGURE 29. Required Dimensions of Model 3011 Front Panel (used to physically stabilize the Switch).

3. To use the Model 3011 for switching feedback elements:

- a. Inside the Model 3011 Switch, connect a wire between the two INPUT Terminals and the solder lug connected to the wiper on the Teflon insulated deck (4, Figure 28).
- b. Connect a second wire from the FEEDBACK Terminal to the wiper on one of the rear component mounting decks (Figure 30).

NOTE

Make sure that the input wires, unless they are Teflon insulated, do not come in contact with any part of the switch except the necessary points of connection.

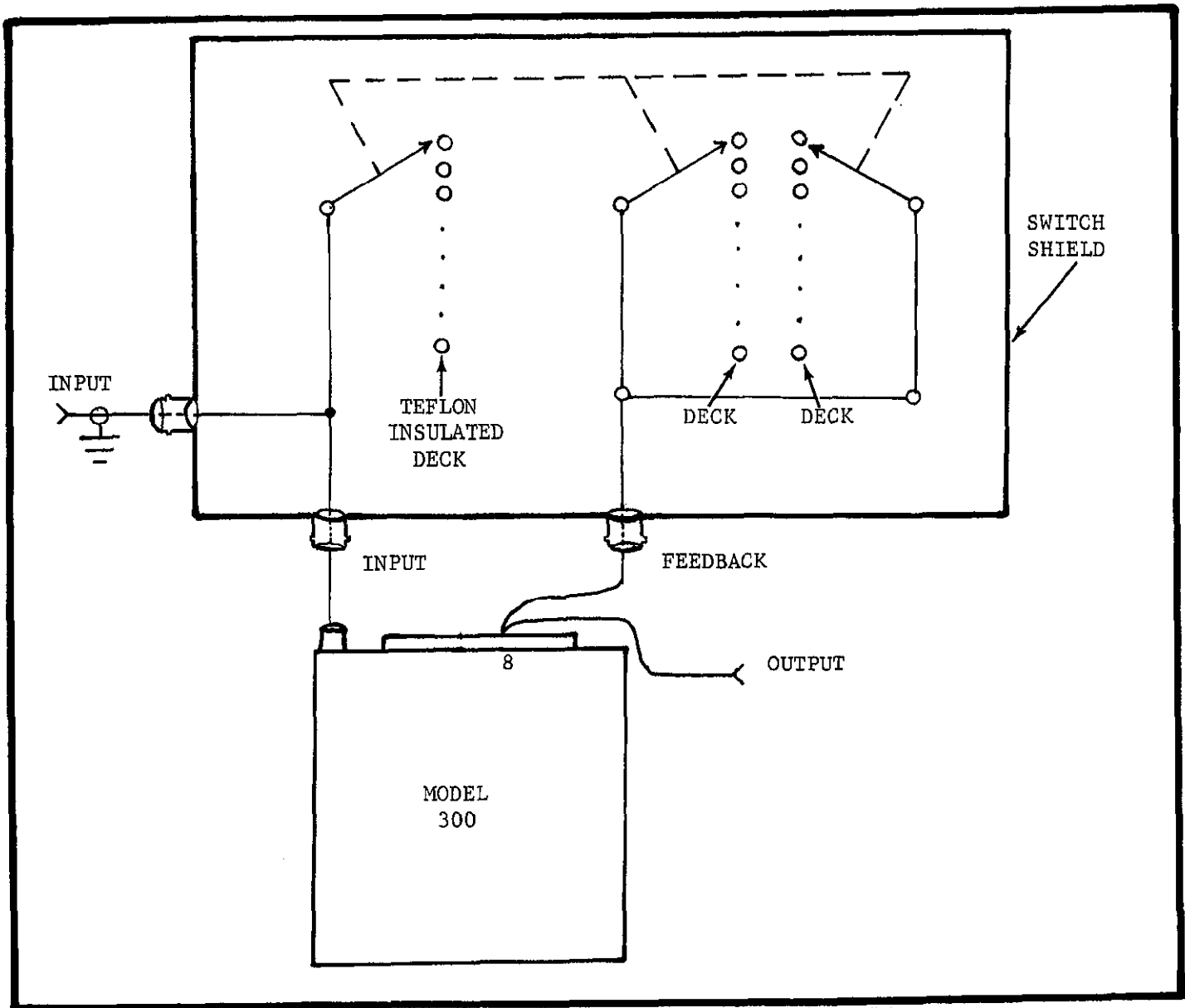

FIGURE 30. Model 3011 Installation and Hook-up Diagram.

SECTION 6. REPLACEABLE PARTS

6-1. REPLACEABLE PARTS LIST. The Replaceable Parts List describes the components of the Model 300 and its accessories. The List gives the circuit designation, the part description, a suggested manufacturer, the manufacturer's part number and the Keithley Part Number. The last column indicates the figure picturing the part. The name and address of the manufacturers listed in the "Mfg. Code" column are in Table 8.

6-2. HOW TO ORDER PARTS.

a. For parts orders, include the instrument's model and serial number, the Keithley Part Number, the circuit designation and a description of the part. All structural parts are those parts coded for Keithley manufacture (80164) must be ordered through Keithley Instruments, Inc. or its representatives. In ordering a part not listed in the Replaceable Parts List, completely describe the part, its function and its location.

b. Order parts through your nearest Keithley representative or the Sales Service Department, Keithley Instruments, Inc.

amp	ampere	MtF	Metal Film
		My	Mylar
CerD	Ceramic Disc		
Comp	Composition	Ω	ohm
DCb	Deposited Carbon	p	pico (10^{-12})
ETB	Electrolytic Tubular	μ	micro (10^{-6})
f	farad	v	volt
Fig.	Figure		
		w	watt
k	kilo (10^3)	WW	Wirewound
		WWVar	Wirewound Variable
M	Megohms (10^6)		
Mfg.	Manufacturer		

TABLE 7. Abbreviations and Symbols

MODEL 300 REPLACEABLE PARTS LIST

(Refer to Schematic Diagram 19558D for circuit designation)

CAPACITORS

Circuit Desig.	Value	Rating	Type	Mfg. Code	Mfg. Part No.	Keithley Part No.	Fig. Ref.
C101	22 pf	600 v	CerD	72982	ED-22	C22-22P	24
C102	*.068 μ f	100 v	My	88480	3FR 683-1E	C146-.068M	23
C201	330 pf	600 v	CerD	72982	ED-330	C22-330P	23
C202	125 μ f	15 v	ETB	56289	TE 1162	C3-125M	24

DIODES

Circuit Desig.	Type	Number	Mfg. Code	Keithley Part No.	Fig. Ref.
D101	Silicon	1N645	01295	RF-14	23
D201	Silicon	1N645	01295	RF-14	23
D202	Silicon	1N645	01295	RF-14	23
D203	Silicon	1N645	01295	RF-14	23
D204	Silicon	1N645	01295	RF-14	23
D205	Zener	1N936	04713	DZ-5	23

MISCELLANEOUS PARTS

Circuit Desig.	Description	Mfg. Code	Keithley Part No.	Fig. Ref.
J101	Coaxial Receptacle (Mfg. No. FXR 2175	02660	CS-178	24
---	(F)Plug, Mate of J101 (Mfg. No. FXR 30775)	02660	CS-179	--
---	(F)Hooded Shield for CS-179 (Mfg. No. FXR 2275)	02660	CS-180	--
---	(F)Connector, 15 pin card-edge (Mfg. No. PSC4SS15-12)	03612	CS-175-15	--
V101	Electrometer tube	80164	EV-5886-5	24
V102	Electrometer tube	80164	EV-5886-5	24

RESISTORS

Circuit Desig.	Value	Rating	Type	Mfg. Code	Mfg. Part No.	Keithley Part No.	Fig. Ref.
R101	10 M Ω	10%, 1/2 w	Comp	01121	EB	R1-10M	24
R102	150 k Ω	1%, 1/2 w	MtF	07716	CEC	R94-150K	22
R103	*68 Ω	10%, 1/2 w	Comp	01121	EB	R1-*68	22
R104	91 Ω	3%, 1 w	WW	02985	400TS-1W	R81-91	22
R105	150 Ω	1%, 1/2 w	MtF	07716	CEC	R94-150K	22

*Nominal value, factory set

(F)Furnished accessory

RESISTORS (Con't)

Circuit Desig.	Value	Rating	Type	Mfg. Code	Mfg. Part No.	Keithley Part No.	Fig. Ref.
R106	500 Ω	3%, 1 w	WW	02985	400TS-1W	R81-500	22
R107	10 k Ω	10%, 1/2 w	Comp	01121	EB	R1-10K	22
R108	100 k Ω	10%, 1/2 w	Comp	01121	EB	R1-100K	22
R109	10 k Ω	10%, 1/2 w	Comp	01121	EB	R1-10K	22
R110	100 k Ω	10%, 1/2 w	Comp	01121	EB	R1-100K	22
R111	8.2 k Ω	10%, 1/2 w	Comp	01121	EB	R1-8.2K	22
R112	5 k Ω	10%, 1/2 w	WWVar	80294	3067P-1-502	RP39-5K	22
R113	2.7 k Ω	10%, 1/2 w	Comp	01121	EB	R1-2.7K	22
R114	2.7 k Ω	10%, 1/2 w	Comp	01121	EB	R1-2.7K	22
R115	33 k Ω	10%, 1/2 w	Comp	01121	EB	R1-33K	22
R116	8.2 k Ω	10%, 1/2 w	Comp	01121	EB	R1-8.2K	22
R117	680 Ω	10%, 1/4 w	Comp	01121	CB	R76-680	22
R118	22 k Ω	10%, 1/2 w	Comp	01121	EB	R1-22K	22
R119	39 Ω	10%, 1/2 w	Comp	01121	EB	R1-39	22
R120	220 k Ω	10%, 1/2 w	Comp	01121	EB	R1-220K	22
R121	10 Ω	10%, 1/2 w	Comp	01121	EB	R1-10	22
R201	15 k Ω	10%, 1/4 w	Comp	01121	CB	R76-15K	22
R202	10 k Ω	10%, 1/4 w	Comp	01121	CB	R76-10K	22
R203	22 k Ω	10%, 1/4 w	Comp	01121	CB	R76-22K	22
R204	6.8 Ω	10%, 1/4 w	Comp	01121	CB	R76-6.8	22
R205	1 k Ω	10%, 1/4 w	Comp	01121	CB	R76-1K	22
R206	3.3 k Ω	10%, 1/4 w	Comp	01121	CB	R76-3.3K	22
R207	4.7 k Ω	10%, 1/4 w	Comp	01121	CB	R76-4.7K	22
R208	3.3 k Ω	10%, 1/4 w	Comp	01121	CB	R76-3.3K	22
R209	2 k Ω	10%, 1/2 w	WWVar	80294	3067-1-502	RP39-2K	22
R210	8.2 k Ω	10%, 1/4 w	Comp	01121	CB	R76-8.2K	22
R211	9 k Ω	1%, 1/2 w	DCb	79727	CFE-15	R12-9K	24
R212	8.6 k Ω	1%, 1/2 w	DCb	79727	CFE-15	R12-8.6K	22

TRANSISTORS

Circuit Desig.	Number	Mfg. Code	Keithley Part No.	Fig. Ref.
Q101	A1380	80164	**18548A	23
Q102	A1380	80164	**18548A	23
Q103	A1380	80164	**18548A	23
Q104	A1380	80164	**18548A	23
Q105	S17638	07263	TG-33	23

** Q101, Q102 and Q103, Q104 are matched pairs. Order only from Keithley Instruments, Inc.

TRANSISTORS (Cont'd)

Circuit Desig.	Number	Mfg. Code	Keithley Part No.	Fig. Ref.
Q106	1L7638	07263	TG-33	23
Q107	2N2430	73445	TG-36	23
Q108	2N2706	73445	TG-35	23
Q201	2N1605	93332	TG-22	23
Q202	2N2431	73445	TG-37	23
Q203	2N2270	02735	TG-25	23
Q204	A1380	73445	TG-32	23
Q205	1L7638	07263	TG-33	23
Q206	A1380	73445	TG-32	23
Q207	A1380	73445	TG-32	23

MODEL 3012 REPLACEABLE PARTS LIST

(Refer to Schematic Diagram 20351B for circuit designations)

Circuit Desig.	Description	Mfg. Code	Keithley Part No.
C101	Capacitor, Electrolytic aluminum, 400 μ f, 40 v (Mfg. No. C437AR/G400)	73445	C150-400M
C102	Capacitor, Electrolytic aluminum, 100 μ f, 40 v (Mfg. No. C437AR/G100)	73445	C150-100M
D101	Diode, Silicon, 1N3253	02735	RF-20
D102	Diode, Silicon, 1N3253	02735	RF-20
D103	Diode, Silicon, 1N3253	02735	RF-20
D104	Diode, Silicon, 1N3253	02735	RF-20
F101	Fuse, 1/8 amp, 8AG (Mfg. No. 361.125)	75915	FU-5
F102	Fuse, 1/8 amp, 8AG (Mfg. No. 361.125)	75915	FU-5
J101	Connector, part of pc board	---	---
---	Connector, furnished mating 15 pin card-edge	80164	CS-175-4
R101	Resistor, Composition, 2.2 k Ω , 10%, 1 w (Mfg. No. GB)	01121	R2-2.2K
T101	Transformer	80164	TR-97

01121	Allen-Bradley Corp. Milwaukee, Wis.	07716	International Resistance Co. Burlington, Iowa
01295	Texas Instruments, Inc. Semi Conductor-Components Division Dallas, Texas	13050	Potter Co. Wesson, Miss.
02660	Amphenol-Borg Electronics Corp. Broadview, Chicago, Illinois	56289	Sprague Electric Co. North Adams, Mass.
02735	Radio Corp. of America Commercial Receiving Tube and Semiconductor Division Somerville, N. J.	72982	Erie Technological Products, Inc. Erie, Pa.
02985	Tepro Electric Corp. Rochester, N. Y.	73445	Amperex Electronic Co. Division of North American Philips Co., Inc. Hicksville, N. Y.
03612	Burndy Corp. Lynwood, Calif.	79727	Continental-Wirt Electronics Corp. Philadelphia, Pa.
04713	Motorola, Inc. Semiconductor Products Division Phoenix, Arizona	80164	Keithley Instruments, Inc. Cleveland, Ohio
07263	Fairchild Camera and Instrument Corp. Semiconductor Division Mountain View, Calif.	80294	Bourns Laboratories, Inc. Riverside, Calif.
		93332	Sylvania Electric Products, Inc. Semiconductor Products Division Woburn, Mass.

TABLE 8. Code List of Suggested Manufacturers. (Based on Federal Supply Code for Manufacturers, Cataloging Handbook H4-1.)

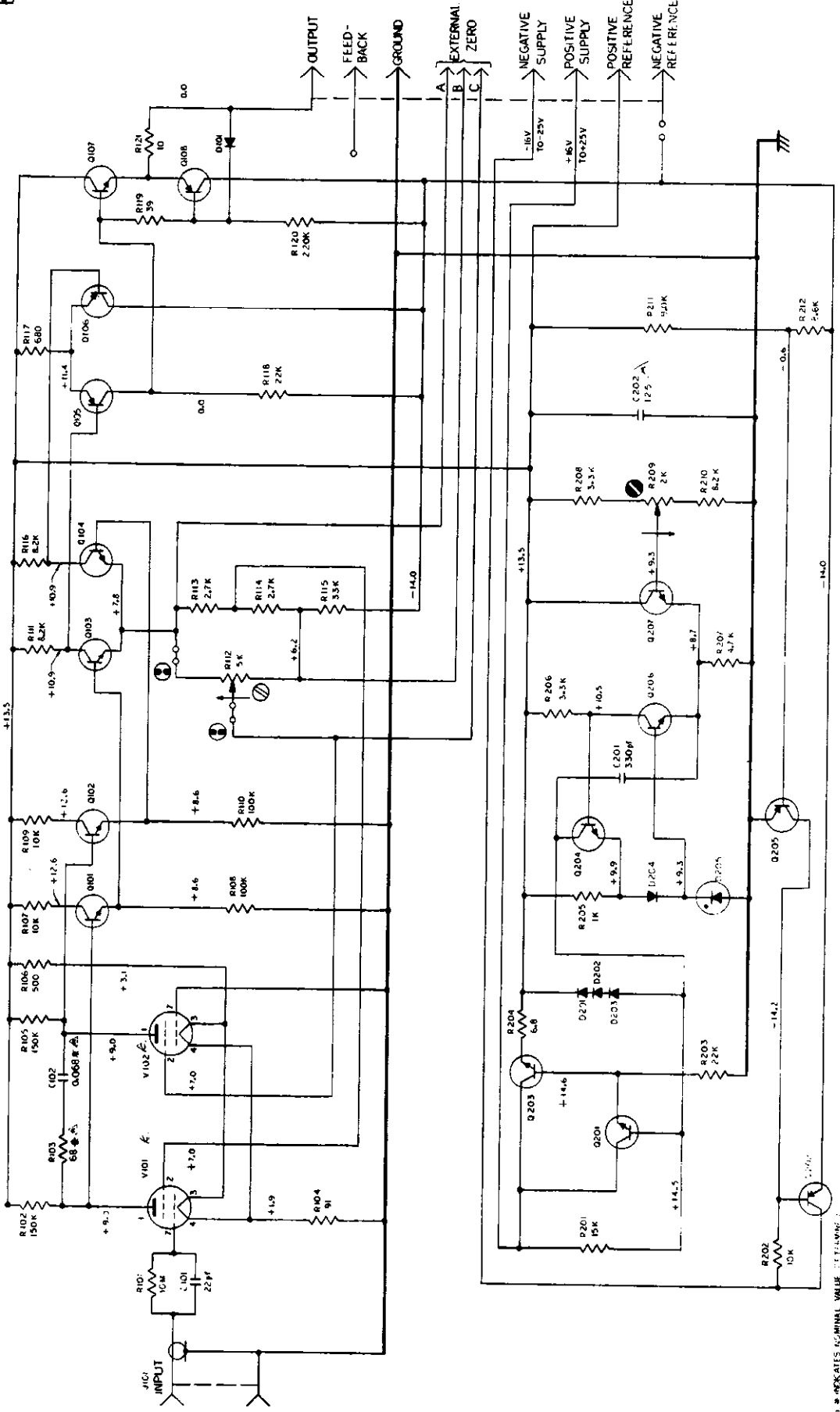

HIGHEST	REFERENCE	DESIGNATION
Q108	J102	D101
Q207	D205	R217
		V102
		C101

13. TYPICAL VALUES MEASURED IN CHARGE: FEEDBACK AND OUTPUT ZEROED.

7. ALL RESISTANCE CAPACITANCE SHALL BE DESIGNATED IN OHMS UNLESS OTHERWISE NOTED. RESISTANCE SHALL BE IN OHMS UNLESS OTHERWISE NOTED.

8. INTERNAL ZERO ADJUSTMENT DISCONNECTION.
 9. COUNTER-CLOCKWISE ROTATION.

RESISTANCE INDUSTRY
 300 SCHEMATIC
 19558D

REVISIONS			
REV.	ECO. NO.	APPR.	DATE
A			

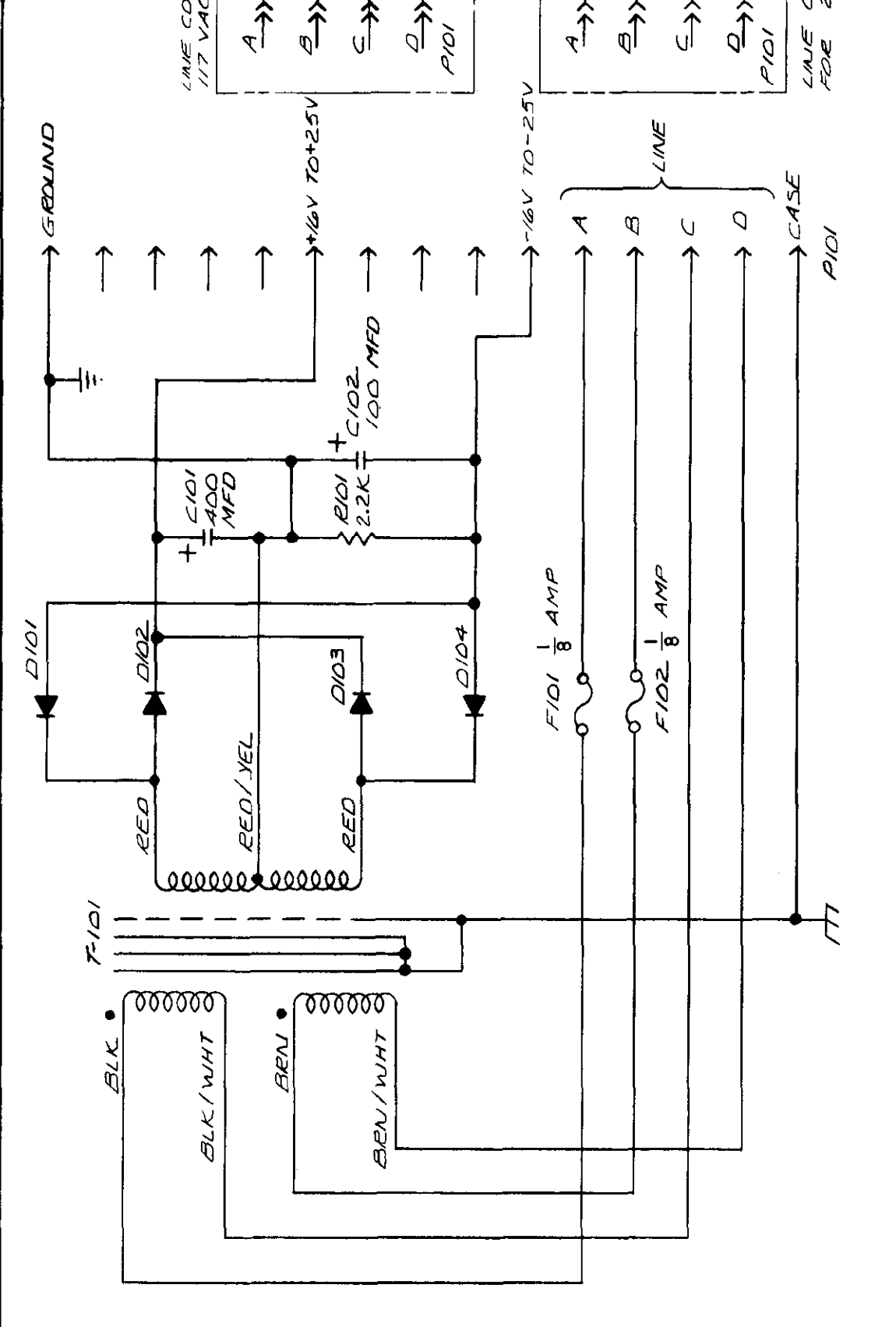

LINE CONNECTION FOR 117 VAC.

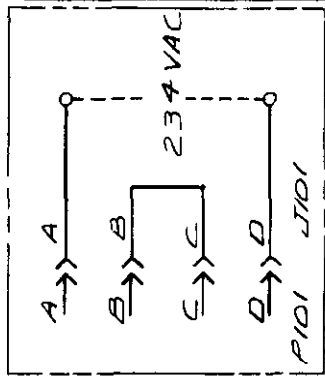
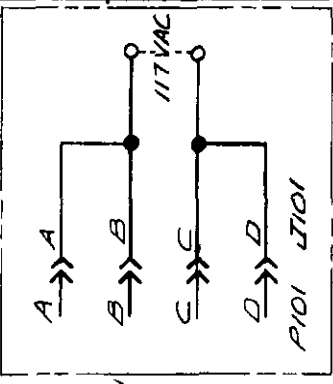

LINE CONNECTION FOR 234 VAC

HIGHEST REF. DESIGNATION	REF. DESIGNATION	NOT USED	DIMENSIONAL TOLERANCES UNLESS OTHERWISE SPECIFIED		DRG. CHECK DATE 8/21/66		KEYTHLEY INSTRUMENTS CLEVELAND, OHIO		TITLE SCHEMATIC 3012	
P101	C102	D104	FRACTIONAL	DECIMAL	ANGLE	ENG. CHK. DATE 9-14-66	MATERIAL		PART NUMBER	
F102	T101	T101	± 1/64	± .005	± 1°	APPR. DATE 9-21-66	FINISH		20351B	
P101			DO NOT SCALE		PILOT RELEASE DATE 9-31-66					
					PROD. RELEASE DATE 11/23/66					



KEITHLEY INSTRUMENTS, INC.

28775 AURORA ROAD • CLEVELAND, OHIO 44139 • (216) 248-0400
TELEX: 98-5469 • CABLE: KEITHLEY